

VIZULO



Blackbird

HANGING



Architectural & Landscape

Outdoor Industrial Area

Residential Street/Area

Ventilation cable gland

Combines pressure equalization and cable gland in a single unit. It ensures high air flow rates as well as high water protection capacity

Glass

Flat glass. Glass is fixed to die-cast aluminium frame with screws

LED module

High quality LED's with optimal thermal resistance and energy consumption characteristic, for high lumen output and long expected life time. Color temperature available: 2700 K, 3000 K, 4000 K

(1800 K, 2200 K, 3500 K, 5000 K, 5700 K, 6500 K available on customer request)

Sockets

Zhaga and NEMA sockets compatible

Protection

IP66 for the complete luminaire

Module temperature control

The LED driver will start reducing the light output when the LED's approach critical temperature. The temperature is measured via a sensor placed on the PCB

(function available on customer request)

Body

Die-cast aluminium

Lighting protection

Built-in surge protection starting from 6 kV till 10 kV

Light regulation

BLACKBIRD drivers offer integrated midnight dimming and network-controlled 1-10 V and DALI protocols

Impact resistance

IK10 (Vandal protected)
for the complete luminaire

Traffic Roads

Pedestrian Roads

City Centre

Midnight dimming

Midnight dimming provides multi-stage night-time power reduction based on an internal timer referenced to the power on/off time. There is no need for an external control infrastructure. The unit automatically performs a dimming profile based on the predefined scheduled reference to the midpoint, which is calculated based on the power on/off times.

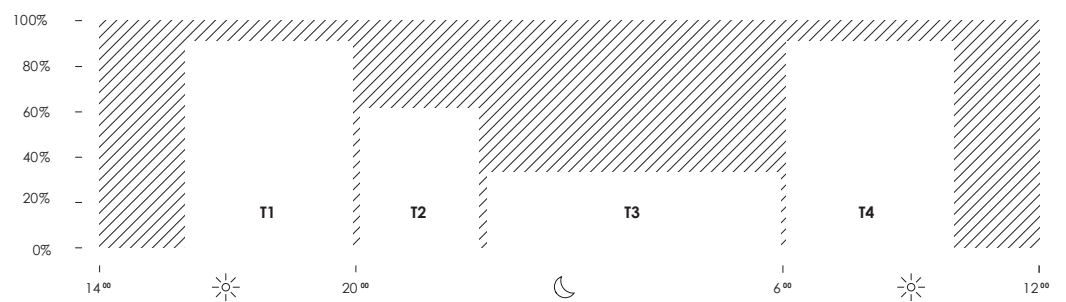

Blackbird hanging

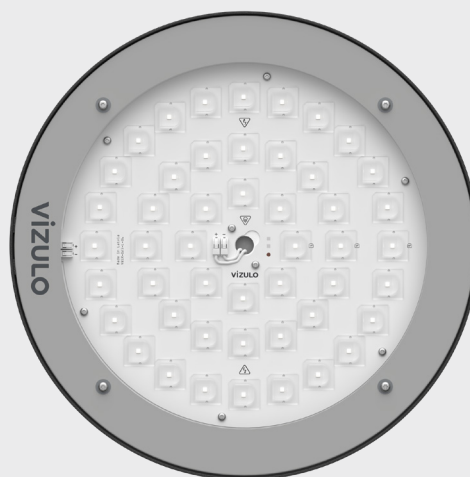
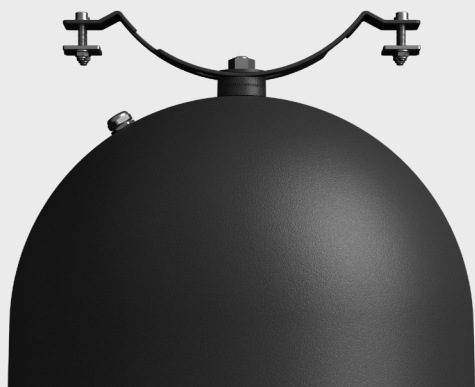

Note! Glass with gray print is standard (black print glass on request!)



RAL7035



RAL9006



DB703



RAL9005

Other colors available on request

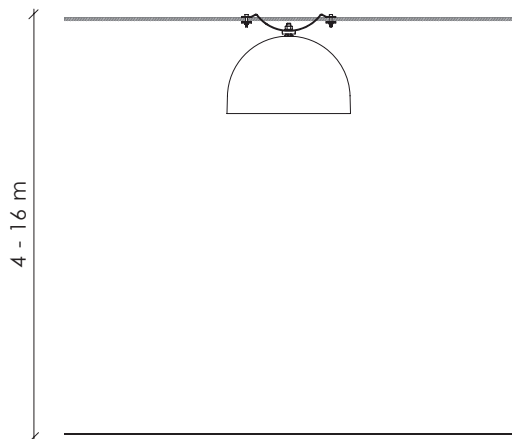
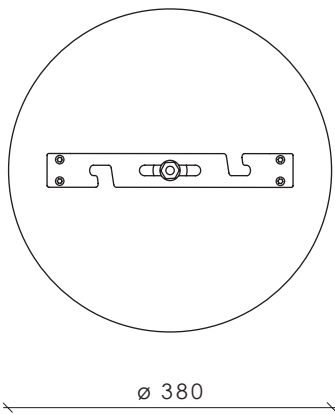
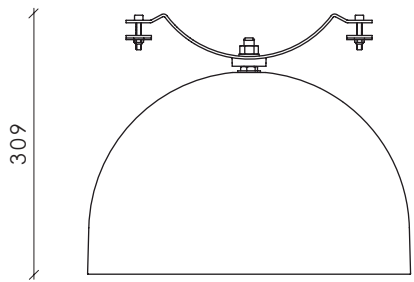

Note! Only those models with fixed mounting position (0° relative to the ground) are DarkSky approved!

Blackbird hanging with Halo



BLACKBIRD HALO

PMMA, matt standard Art. 70082006

PMMA, matt for Zhaga Bottom Art. 70082025

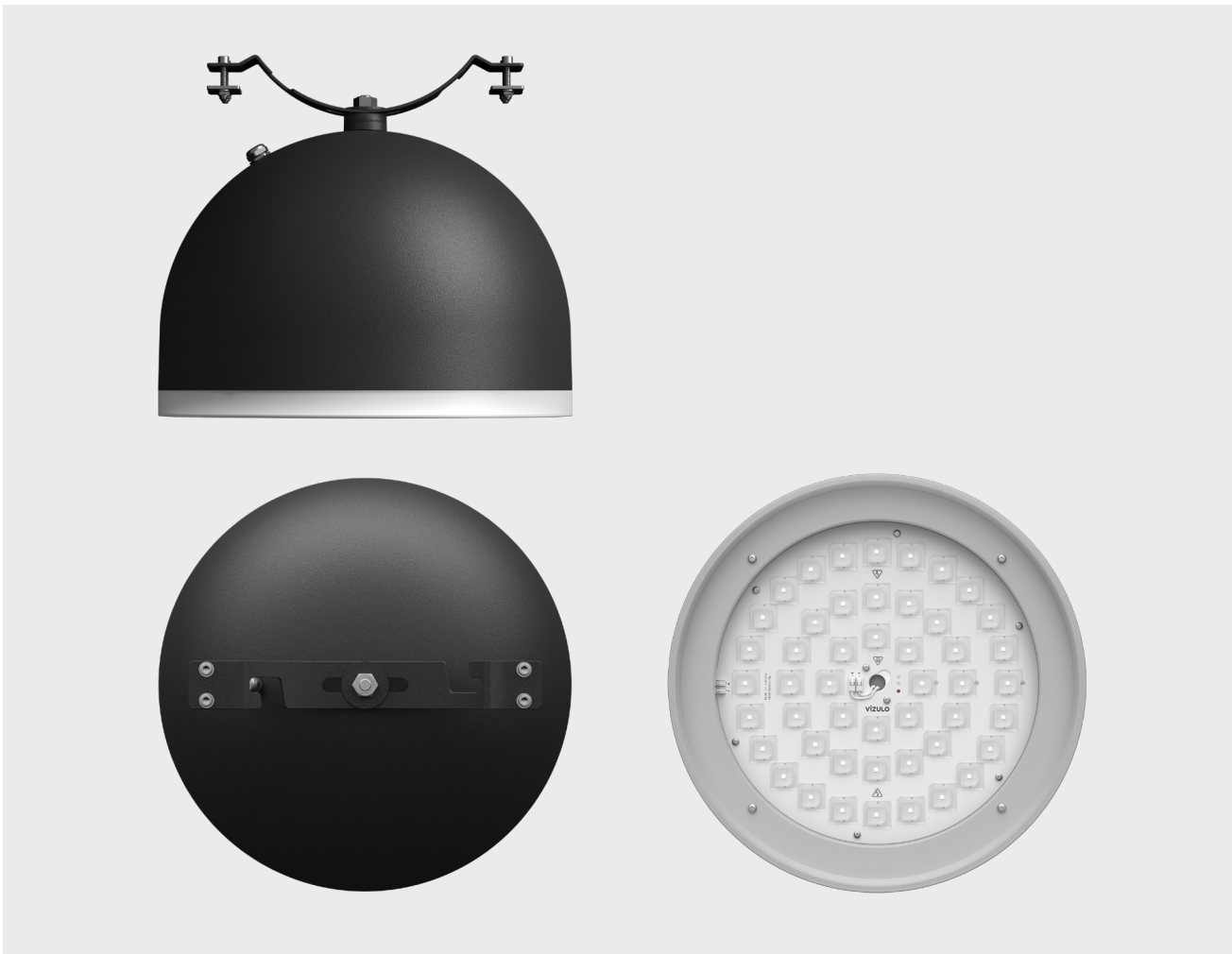

RAL7035



RAL9006



DB703



RAL9005

Other colors
available on request

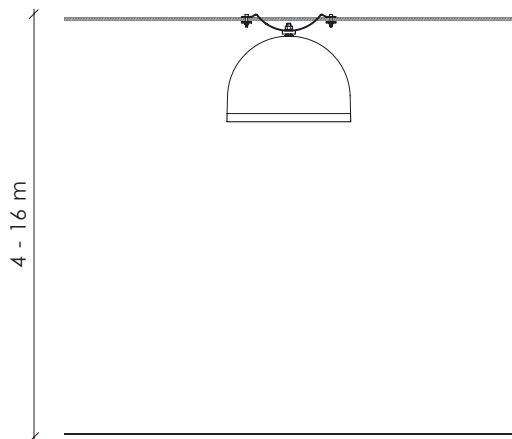
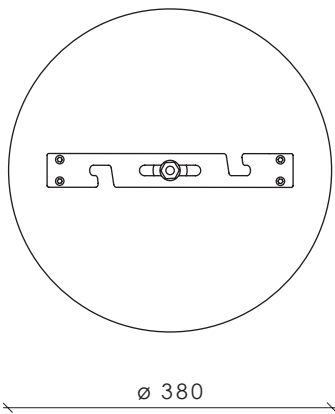
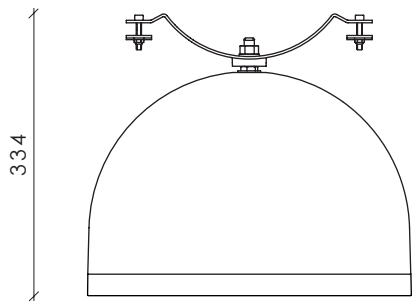

Note! Only those models with fixed mounting position (0° relative to the ground) are DarkSky approved!

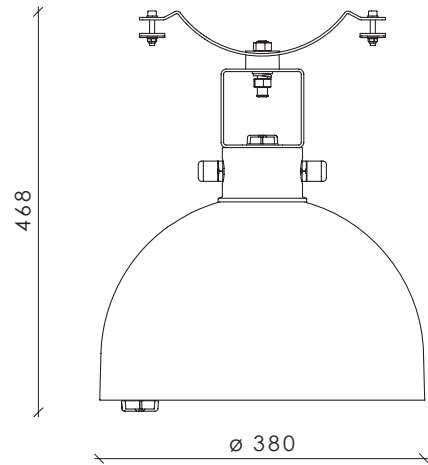
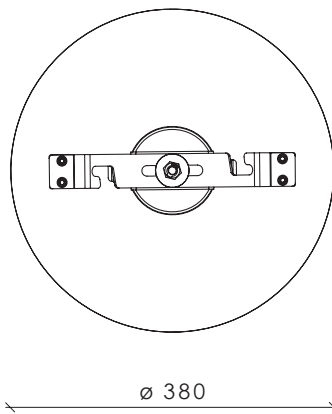
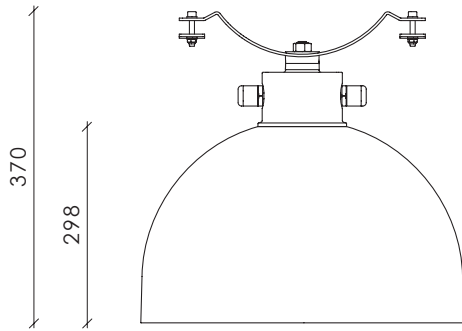

Dimensions with 2 Zhaga connectors

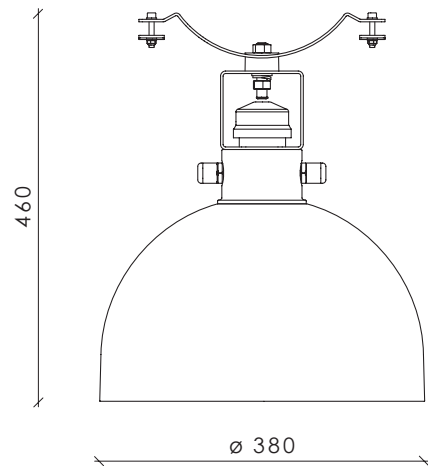

Dimensions with NEMA socket

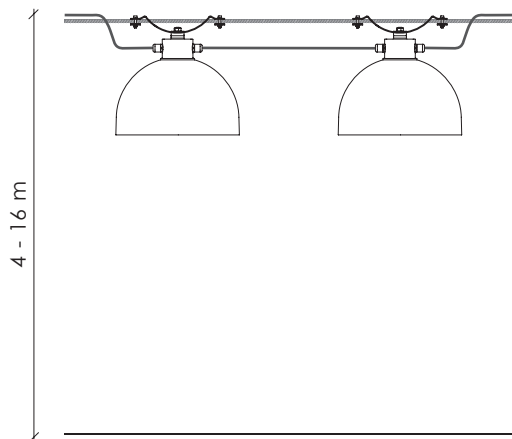

Note! Only those models with fixed mounting position (0° relative to the ground) are DarkSky approved!

Technical information



V	198 - 264 / 110 - 277 ¹⁾
Hz	50 - 60
W	5 - 100
lm	441 - 15500 ²⁾
lm/W	88 - 160
K	2700 / 3000 / 4000 / TW 2700 - 6500 ³⁾
°C	-40 up to +50 ⁴⁾
CRI	>70 / >80 / >90 ³⁾

Body:	Die-cast aluminium
Dimming:	DALI / 1-10 V / Midnight dimming / Step dimming / Mains dimming
Initial chromaticity:	MacAdam 5
Lifetime:	Eco 100 000 h (L90B10) at Ta = 25 °C* Standard 100 000 h (L98B10) at Ta = 25 °C* High density 100 000 h (L98B10) at Ta = 25 °C*
Warranty:	5 years
Installation:	Pre-wired cable 30 cm ⁵⁾
Mounting:	On wire ø 5 - 12 mm
Socket:	NEMA Top / Zhaga Top and Bottom
Intelligent Control:	Stand-alone / Group / CMS
Sensor:	Motion / Motion + Daylight / Daylight
Surge protection:	4 / 6 / 10 kV ⁶⁾
Corrosion protection:	Up to C5
Neto weight:	Up to 7.8 kg
Max. wind load area, SCd:	0.09 m ²

¹⁾ Maximum operating voltage, ENEC certificate voltage 220 - 240 V, UL certificate voltage 110 - 277 V

²⁾ Lumen output indicated at CRI > 70

³⁾ 1800 / 2200 / 3500 / 5000 / 5700 / 6500 K available on request along with other not listed CRI and CCT

Note! Only fixtures with CCT of 3000 K or lower are DarkSky approved!

⁴⁾ Operating temperature differs depending on chosen output wattage

⁵⁾ Other lengths available on request

⁶⁾ 10 kV (L-N; L/N-PE) surge protection device available on request

⁷⁾ Coming soon

* This value is only informative and may change according to selected article. LED Lifetime is strongly depending from LEDs current and junction temperature – increase in LED current and luminaire power lead to increase of junction temperature and as consequence lifetime decrease. Thus, luminaire models with lower power, lower current (and lower junction temperature) will have higher lifetime than standard models. And high power and high current luminaire models may have negative lifetime deviation comparing to standard models. To receive precise value please contact VIZULO export representatives.

Technical parameters for final product can differ from typical data by 7% due to special conditions of LED manufacturing processes.

Standard modules

* Data for L01 optic.

Check VIZULO members section for additional information

4000 K | CRI 70

Number of LED's	4			8			16		
Nominal current, mA	270	500	730	140	540	700	270	480	760
Power, W	5	8	11	5	15	19	15	25	39
Luminous Flux, lm	520	900	1300	560	2000	2500	2200	3530	5240
Efficacy, lm/W	104	113	118	110	133	132	147	141	134
Power factor, PF	Up to 0.93			Up to 0.94			Up to 0.98		

Number of LED's	24			32			48		
Nominal current, mA	260	470	700	280	510	680	270	510	680
Power, W	20	35	52	28	50	75	40	75	100
Luminous Flux, lm	3000	5100	7200	4300	7300	10230	6100	11000	14000
Efficacy, lm/W	150	146	138	154	146	136	153	147	140
Power factor, PF	Up to 0.97			Up to 0.97			Up to 0.97		

Luminaire efficacy	2700 K	5 - 100 W	441 - 12000 lm	88 - 134 lm/W
	3000 K	5 - 100 W	485 - 13200 lm	97 - 144 lm/W
	5000 K	5 - 100 W	520 - 14000 lm	104 - 154 lm/W
	5700 K	5 - 100 W	520 - 14000 lm	104 - 154 lm/W

High density modules

* Data for V01 optic.

Check VIZULO members section for additional information

4000 K | CRI 70

Number of LED's	16			24			32		
Nominal current, mA	280	480	760	260	470	700	290	500	760
Power, W	15	25	39	20	35	52	29	50	75
Luminous Flux, lm	2200	3530	5240	3000	5100	7200	4450	7300	10300
Efficacy, lm/W	147	141	134	150	146	138	153	146	137
Power factor, PF	Up to 0.98			Up to 0.97			Up to 0.97		

Number of LED's	48			96		
Nominal current, mA	270	510	680	270	320	350
Power, W	40	75	100	76	90	100
Luminous Flux, lm	6300	11000	14000	12100	14100	15500
Efficacy, lm/W	158	147	140	159	157	155
Power factor, PF	Up to 0.97			Up to 0.98		

Luminaire efficacy	2700 K	15 - 100 W	1840 - 13210 lm	115 - 136 lm/W
	3000 K	15 - 100 W	2015 - 14530 lm	127 - 150 lm/W
	5000 K	15 - 100 W	2200 - 15500 lm	134 - 159 lm/W
	5700 K	15 - 100 W	2200 - 15500 lm	134 - 159 lm/W

Check VIZULO members section for additional information

4000 K | CRI 70

Number of LED's	4			8			16		
Nominal current, mA	140	490	670	280	490	700	140	250	390
Power, W	5	14	19	15	26	38	15	25	39
Luminous Flux, lm	55	1730	2300	2100	3430	4640	2300	3750	5560
Efficacy, lm/W	111	124	121	140	132	122	153	150	143
Power factor, PF	Up to 0.94			Up to 0.98			Up to 0.98		

Number of LED's	24			32			48		
Nominal current, mA	270	530	650	260	380	500	140	260	350
Power, W	42	80	100	50	75	100	40	75	100
Luminous Flux, lm	6050	10600	12400	7620	11000	13400	6410	11500	14500
Efficacy, lm/W	144	133	124	152	147	134	160	153	145
Power factor, PF	Up to 0.98			Up to 0.97			Up to 0.96		

Luminaire efficacy	2700 K	5 - 100 W	520 - 13560 lm	104 - 150 lm/W
	3000 K	5 - 100 W	555 - 14500 lm	111 - 160 lm/W
	5000 K	5 - 100 W	555 - 14500 lm	111 - 160 lm/W
	5700 K	5 - 100 W	555 - 14500 lm	111 - 160 lm/W

Model name principles

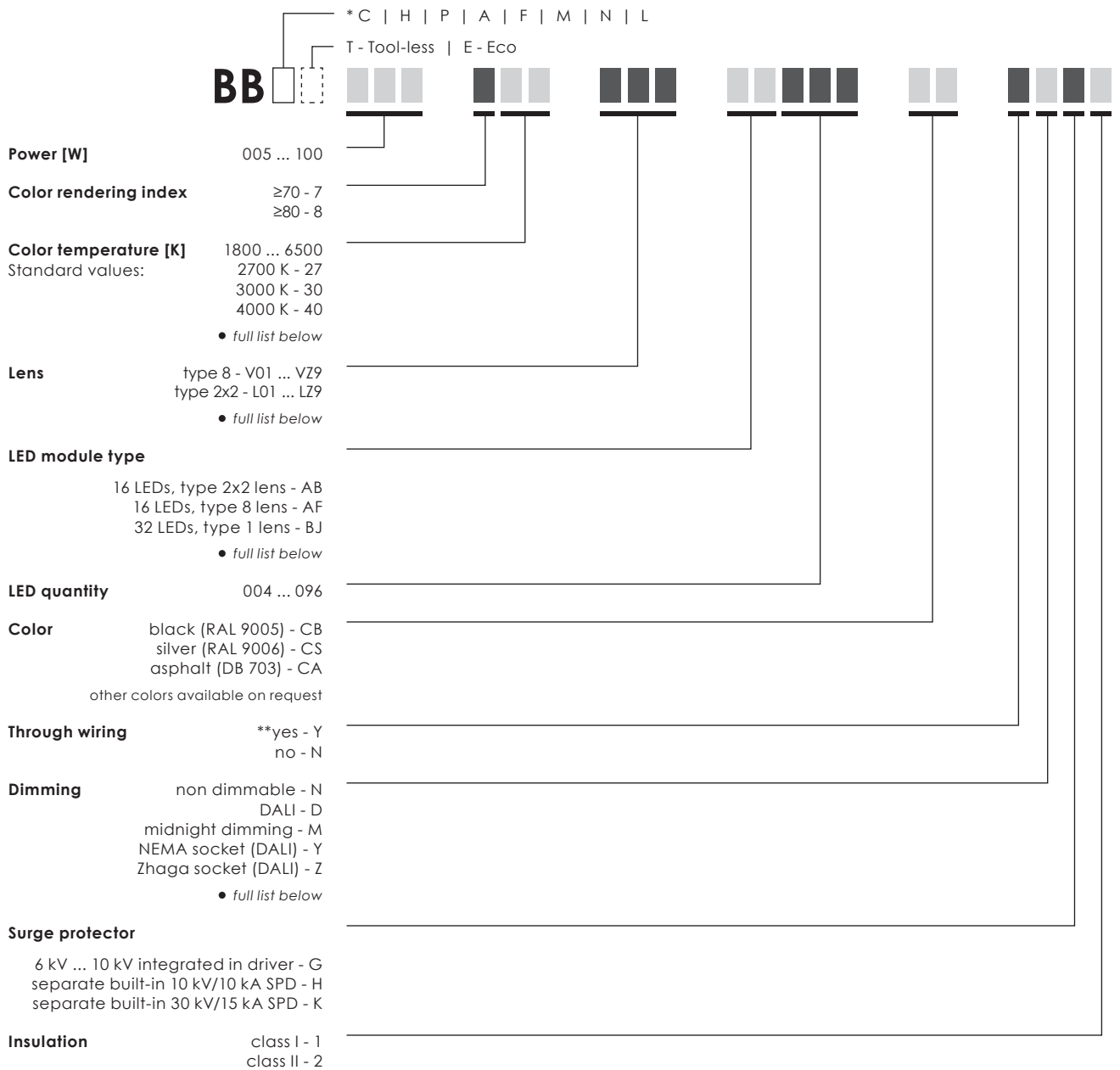

EXAMPLE BBH 050 730 L01 AB032 CB YDG1

• Full list of options

Color temperature [K]

1800 ... 6500
 2700 K - 27
 3000 K - 30
 4000 K - 40
 Tunable White 2700-6500 - TW
 Nature Friendly Red - NR
 Nature Friendly Amber - NA
 Nature Friendly 1800 K - NK

Lens

type 8 - V01 ... VZ9
 type 2x2 - L01 ... LZ9
 type 4x2 - B01 ... BZ9
 type 6x1 - T01 ... TZ9
 type 12 - Y01 ... YZ9
 type 1 - Z01 ... ZZ9
 type 1 micro - U01 ... UZ9
 custom configuration - M01 ... NZ9

Dimming

non dimmable - N
 DALI - D
 1-10 V - A
 midnight dimming - M
 midnight dimming + DALI - R
 step dimming - S
 mains dimming - L
 wireless - W
 NEMA socket (DALI) - Y
 Zhaga socket (DALI) - Z
 ***custom configuration - X

LED module type

8 LEDs, type 2x2 lens - AA
 16 LEDs, type 2x2 lens - AB
 16 LEDs, type 8 lens - AF
 32 LEDs, type 8 lens - AG
 48 LEDs, type 2x2 lens - BE
 96 LEDs, type 8 lens - BF
 4 LEDs, type 2x2 lens - BG
 8 LEDs, type 8 lens - BH
 24 LEDs, type 1 lens - BJ
 24 LEDs, type 2x2 lens - BL
 48 LEDs, type 8 lens - BM
 48 LEDs, type 1 lens - BN
 16 LEDs, type 4x2 lens - BT
 32 LEDs, type 4x2 lens - BU
 96 LEDs, type 4x2 lens - BO
 10 LEDs, type 1 lens - BR
 12 LEDs, type 1 lens - BS

* C - Street (side-entry) | H - Hanging | P - Post-top | A - Top-entry | F - Flood (flood light)
 M - Mushroom (42 - 60 mm) | N - Mushroom (76 mm) | L - Scepter

** Available only for Hanging version

*** CUSTOM CONFIGURATION EXAMPLE:

NEMA socket + Zhaga socket; NEMA socket + Zhaga socket + midnight dimming; etc.
 Custom configuration information is available in order confirmation.

LED modules

Type	Max module QTY	Min LED QTY per module	Max LED QTY per module	Max LED QTY per luminaire	LED step	LED type	Lens type	LED module
AA	4	4	8	32	2	Standard Eco	type 2x2 L01...LZ9	
AF	4	4	16	64	2	Standard	type 8 V01...VZ9	
BT	4	4	16	64	8	Standard	type 4x2 B01...BZ9	

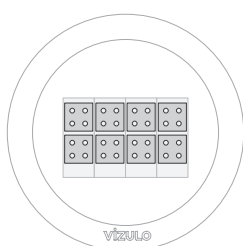

AA032

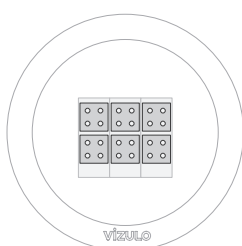

AA024

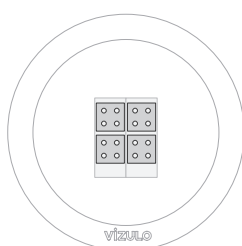

AA016

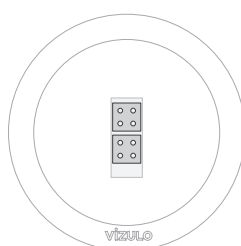

AA008

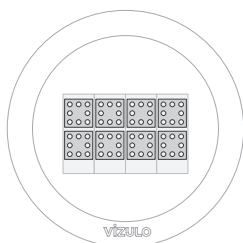

AF064

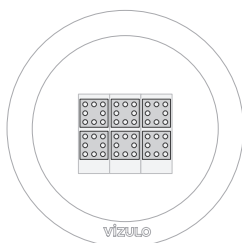

AF048

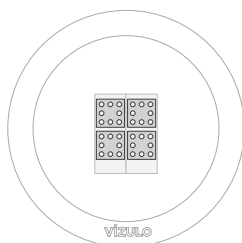

AF032

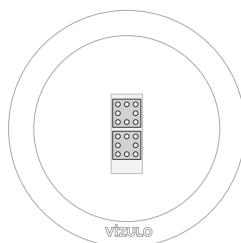

AF016

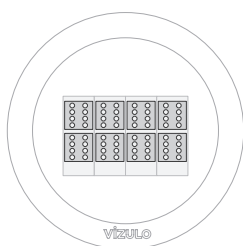

BT064

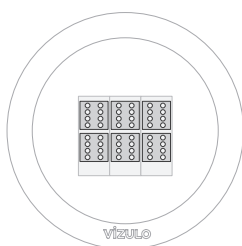

BT048

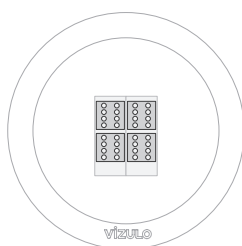

BT032

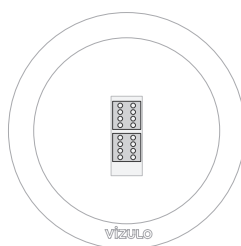

BT016

Type	Max module QTY	Min LED QTY per module	Max LED QTY per module	Max LED QTY per luminaire	LED step	LED type	Lens type	LED module
AB	2	8	16	32	2	Standard Eco	type 2x2 L01...LZ9	
AG	2	16	32	64	2	Standard	type 8 V01...VZ9	
BU	2	16	32	64	8	Standard	type 4x2 B01...BZ9	

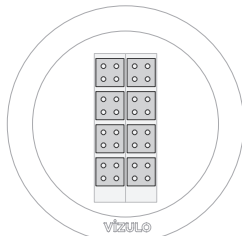

AB032

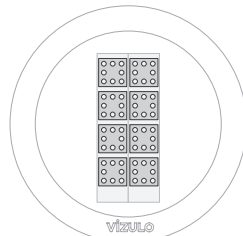

AG064

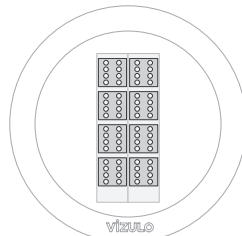

BU064

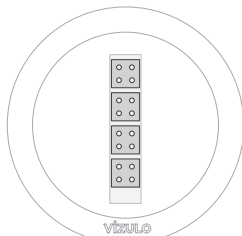

AB016

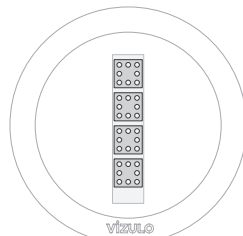

AG032

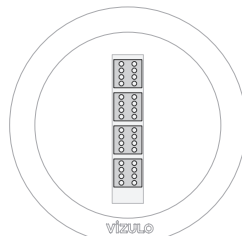

BU032

Type	Max module QTY	Min LED QTY per module	Max LED QTY per module	Max LED QTY per luminaire	LED step	LED type	Lens type	LED module
BG	8	4	4	32	2	Standard Eco	type 2x2 L01...LZ9	
BH	8	4	8	64	2	Standard	type 8 V01...VZ9	

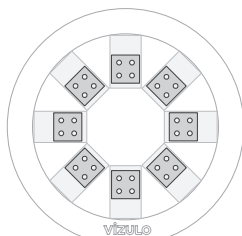

BG032

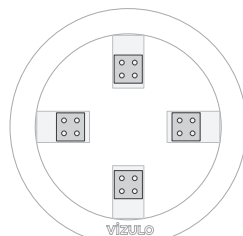

BG016

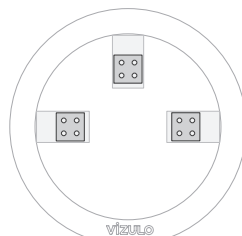

BG012

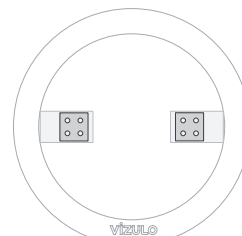

BG008

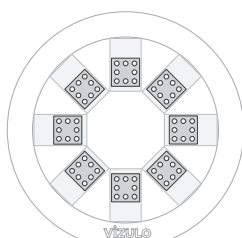

BH064

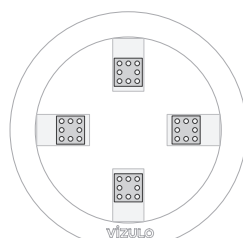

BH032

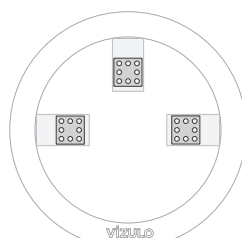

BH024

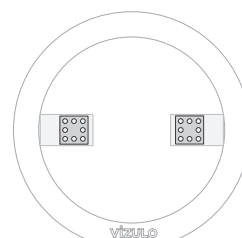

BH016

Type	Max module QTY	Min LED QTY per module	Max LED QTY per module	Max LED QTY per luminaire	LED step	LED type	Lens type	LED module
BE	1	40	48	48	2	Standard Eco	type 2x2 L01...LZ9	
BF	1	72	96	96	4	Standard	type 8 V01...VZ9	
BO	1	72	96	96	8	Standard	type 4x2 B01...BZ9	
BL	1	24	24	24	2	Standard Eco	type 2x2 L01...LZ9	
BM	1	32	48	48	4	Standard	type 8 V01...VZ9	

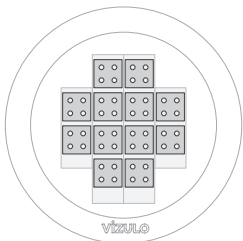

BE048

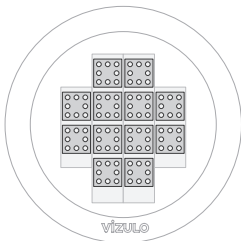

BF096

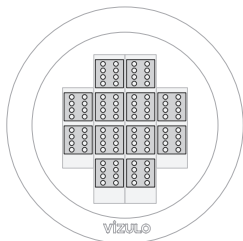

BO096

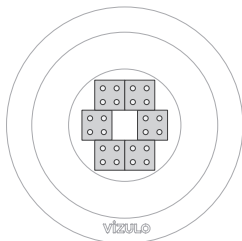

BL024

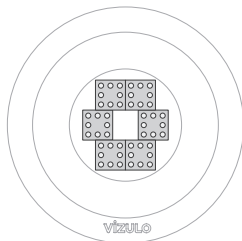

BM048

Type	Max module QTY	Min LED QTY per module	Max LED QTY per module	Max LED QTY per luminaire	LED step	LED type	Lens type	LED module
BN*	1	36	48	48	-	Standard	type 1 Z01...ZZ9	
BJ	1	8	24	24	-	Standard Eco	type 1 Z01...ZZ9	
BR	1	10	10	10	-	Standard	type 1 Z01...ZZ9	
BS	1	12	12	12	-	Standard	type 1 Z01...ZZ9	

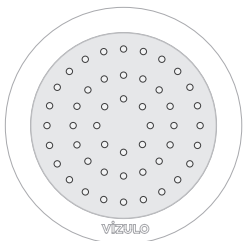

BN048

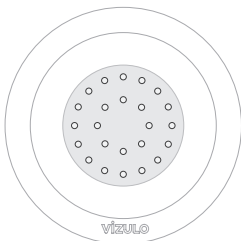

BJ024

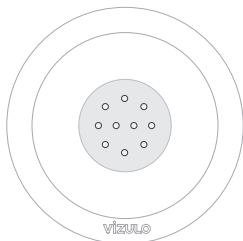

BR010

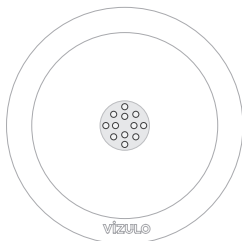

BS012

* Not applicable with Bottom Zhaga socket

Cable core count

Socket	Dimming	Model number abbreviation	Input cable core count - Class I	Input cable core count - Class II
None	None	N	3	2
None	DALI	D	5	4
None	Midnight dimming	M	3	2
None	Midnight dimming + DALI	R	5	4
None	Step dimming	S	5 ⁽¹⁾	4 ⁽¹⁾
None	Mains dimming	L	3	2
Zhaga	DALI	Z	3 ⁽²⁾	2 ⁽²⁾
Zhaga	Midnight dimming	X	3	2
Zhaga	Mains dimming	X	3	2
NEMA	DALI	Y	3 / 5 ⁽³⁾	2 / 4 ⁽³⁾
NEMA	Midnight dimming	X	3	2
NEMA	Step dimming	X	5 ⁽¹⁾	4 ⁽¹⁾
NEMA	Mains dimming	X	3	2

¹⁾ 1 core unused

²⁾ DALI wires used only for internal connection between driver and Zhaga socket(s)

³⁾ +2 cores for external DALI connection

Optics

Standard modules

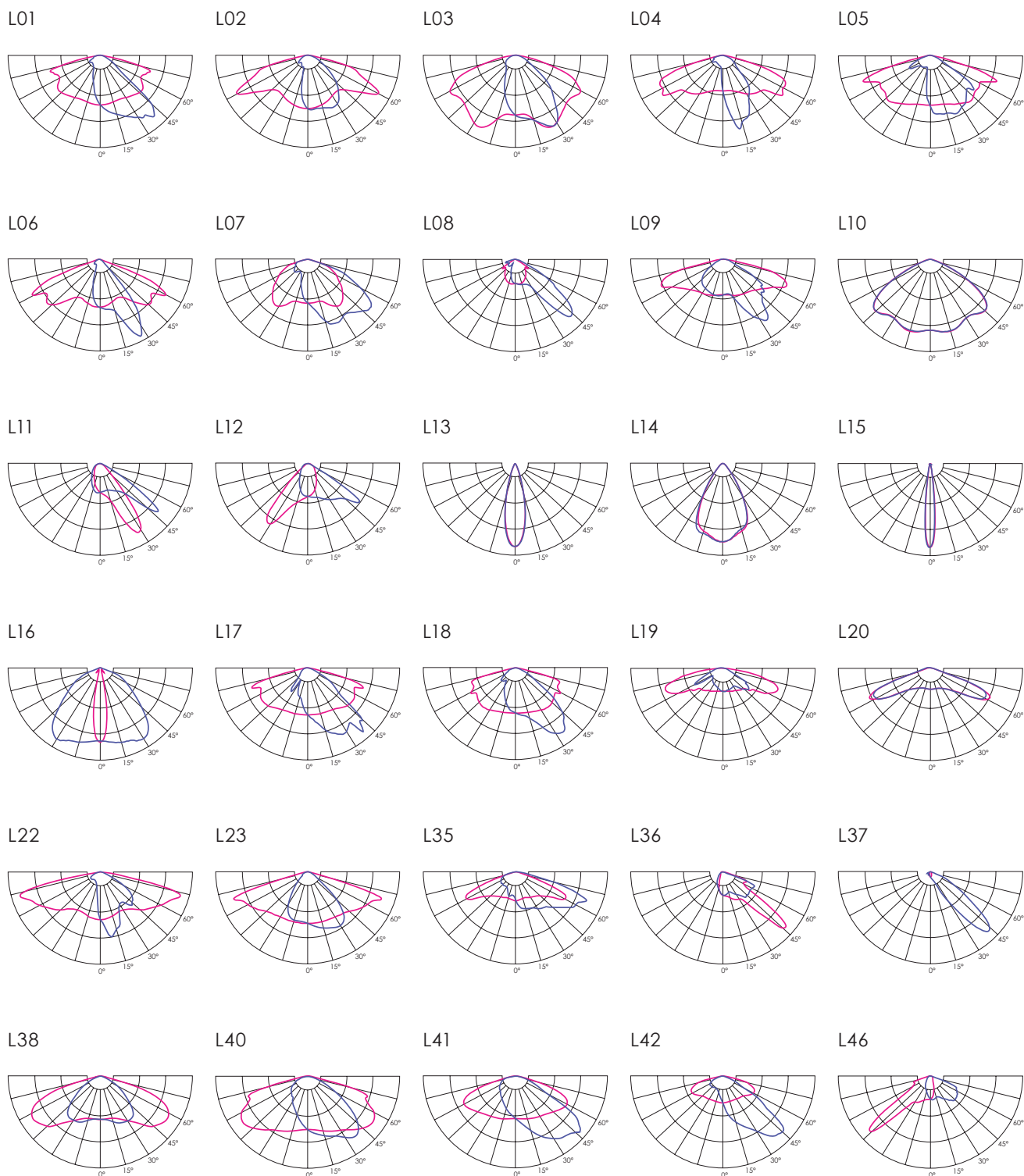

L55

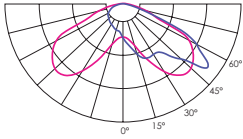

L56

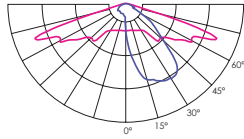

L58

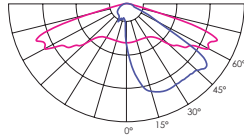

L60

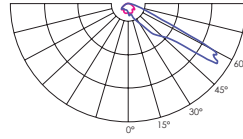

L63

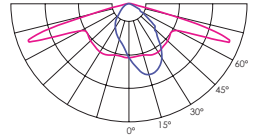

L66

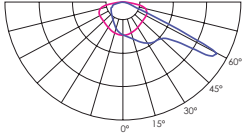

L90

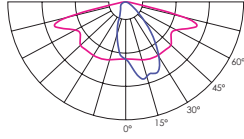

L94

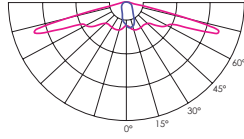

High density modules

V01

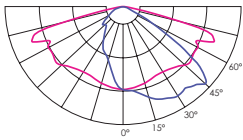

V04

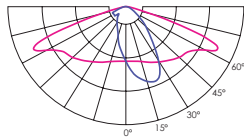

V05

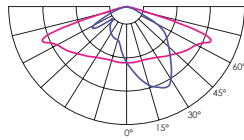

V10

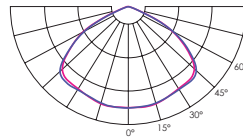

V13

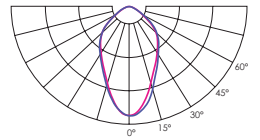

V16

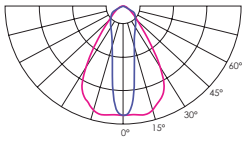

V20

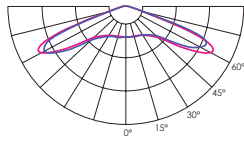

V22

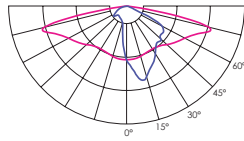

V35

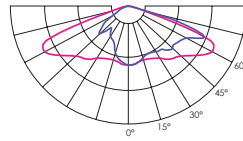

V45

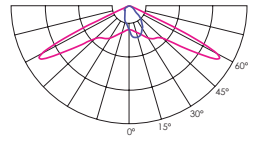

V52

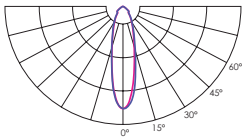

V53

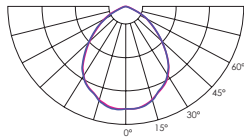

V57

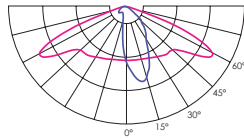



Pedestrian crossing optics



V	198 - 264 / 110 - 277 ¹⁾	Body:	Die-cast aluminium
Hz	50 - 60	Dimming:	DALI / 1-10 V / Midnight dimming / Step dimming / Mains dimming
W	5 - 100	Initial chromaticity:	MacAdam 5
lm	Up to 14000 ²⁾	Lifetime:	Eco 100 000 h (L90B10) at Ta = 25 °C* Standard 100 000 h (L98B10) at Ta = 25 °C*
lm/W	Up to 14500 ³⁾	Warranty:	5 years
	88 - 154 ²⁾	Installation:	Pre-wired cable 30 cm ⁶⁾
	104 - 160 ³⁾	Mounting:	On wire ø 5 - 12 mm
K	2700 / 3000 / 4000 /	Socket:	NEMA Top / Zhaga Top and Bottom
	TW 2700 - 6500 ⁴⁾	Intelligent Control:	Stand-alone / Group / CMS
°C	-40 up to +50 ⁵⁾	Sensor:	Motion / Motion + Daylight / Daylight
CRI	>70 / >80 / >90 ⁴⁾	Surge protection:	4 / 6 / 10 kV ⁷⁾
		Corrosion protection:	Up to C5
		Neto weight:	Up to 7.8 kg
		Max. wind load area, SCd:	0.09 m ²

¹⁾ Maximum operating voltage, ENEC certificate voltage 220 - 240 V, UL certificate voltage 110 - 277 V

²⁾ Standard modules, lumen output indicated at CRI > 70

³⁾ ECO modules, lumen output indicated at CRI > 70

⁴⁾ 1800 / 2200 / 3500 / 5000 / 5700 / 6500 K available on request along with other not listed CRI and CCT

Note! Only fixtures with CCT of 3000 K or lower are DarkSky approved!

⁵⁾ Operating temperature differs depending on chosen output wattage

⁶⁾ Other lengths available on request

⁷⁾ 10 kV (L-N; L/N-PE) surge protection device available on request

⁸⁾ Coming soon

* This value is only informative and may change according to selected article. LED Lifetime is strongly depending from LEDs current and junction temperature – increase in LED current and luminaire power lead to increase of junction temperature and as consequence lifetime decrease. Thus, luminaire models with lower power, lower current (and lower junction temperature) will have higher lifetime than standard models. And high power and high current luminaire models may have negative lifetime deviation comparing to standard models. To receive precise value please contact VIZULO export representatives.

Technical parameters for final product can differ from typical data by 7% due to special conditions of LED manufacturing processes.

Right side traffic

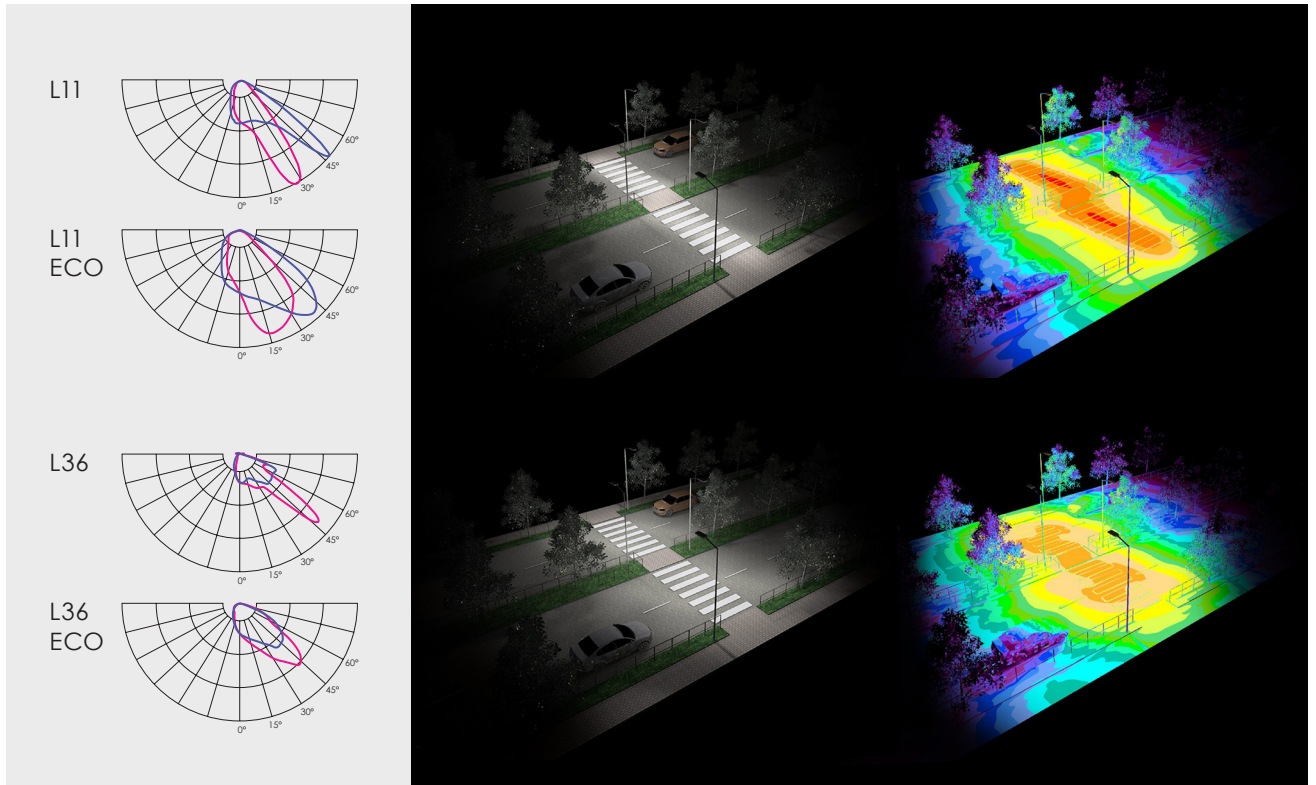

Left side traffic

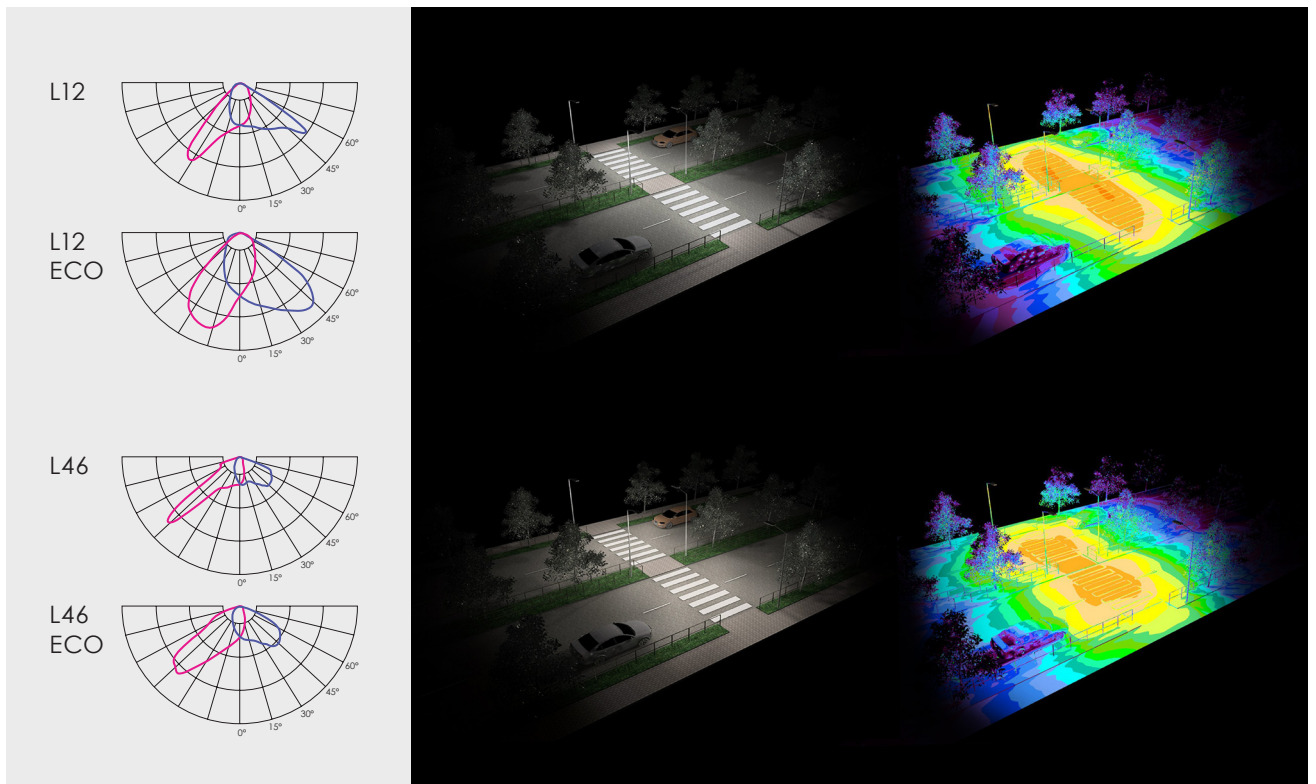

Backlight cutter

Backlight cutter | black

Art. 70000661



Backlight cutter | white

Art. 70000662

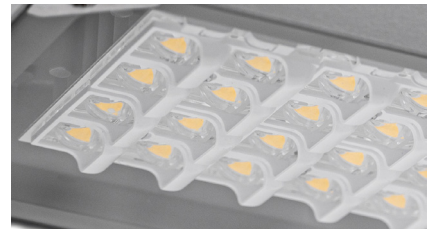

Optical losses from 10% to 31% depending from used optic.

Without backlight cutter

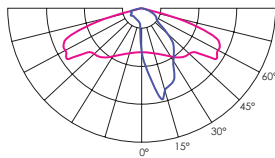

Backlight cutter | black

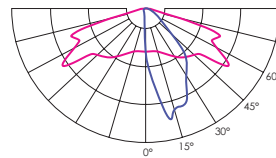

Backlight cutter | white

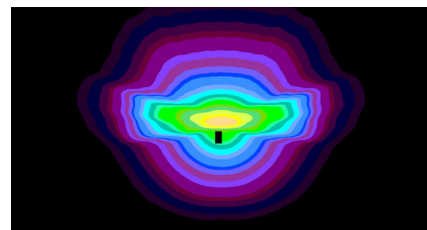
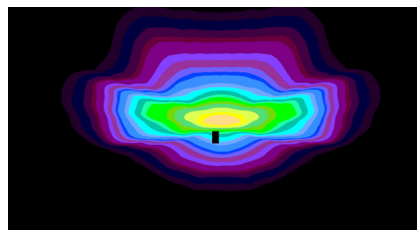
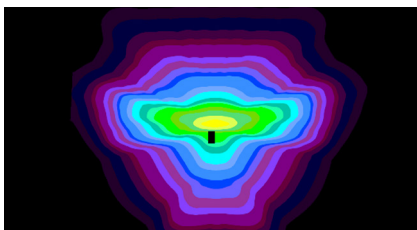
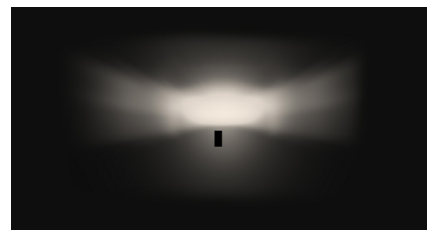
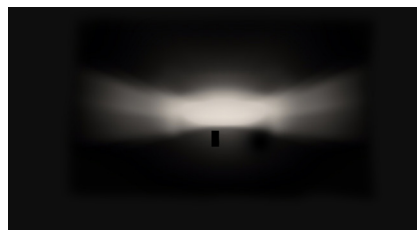
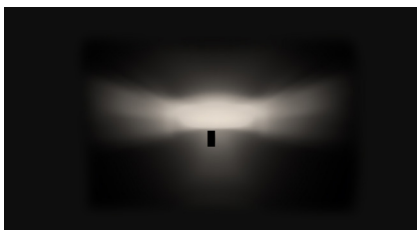
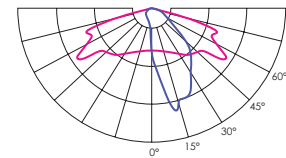

Accessories

Blackbird halo

PMMA, matt standardArt. 70082006
 PMMA, matt for Zhaga BottomArt. 70082025

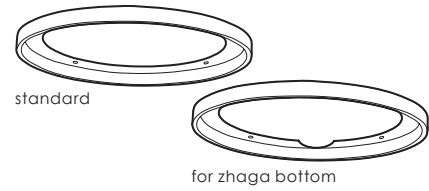

Blackbird skirt

RAL 9005Art. 70082023
 RAL 9005 with primerArt. 70082021

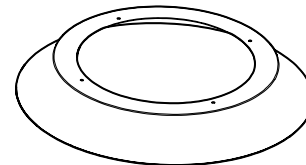

MAUGLO Segment controller

Art. 70010004

Segment Controller receives commands from MAUGLO server via GSM and transmits tasks to Luminaire Controller via radio frequency communication.

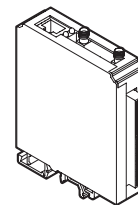

MAUGLO Luminaire controller

Art. 70010001 /
 LC2M-23-05-R Luminaire
 Controller - 2 relays

Luminaire Controller is wireless mesh-networking device that uses 868 MHz for communication with Segment Controller and other Luminaire Controllers. It is delivered in various configurations to meet the needs of your applications.

Art. 70010002 /
 LC2M-12-05-R Luminaire
 Controller - 1 relay

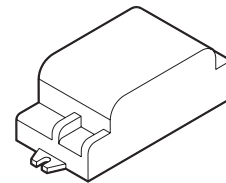

MAUGLO Surge Protection device

Art. 70020001

Surge Protection device offers protection against lighting surges;
 Voltage Protection level up (L-N) $\leq 1,5$ kV
 Voltage Protection level up (L/N-PE) $\leq 2,0$ kV
 $U_{oc} = 10$ kV
 $I_{max} = 10$ kA
 $I_{nom} = 5$ kA

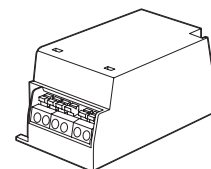

Radio Frequency Antenna

Art. 70000108

Heavy duty IP67 enclosure
 Mounted in cabinet or luminaire body
 with 14 mm screw
 SMA connector



NEMA Socket

2213362-3, 5 pin NEMA socket 105°C wires
 2213362-4, 7 pin NEMA socket 105°C wires

Art. 70000362
 Art. 70000333



Dummy Link for NEMA Socket

Art. 70000113



Zhaga socket no cap

Art. 70000612



Zhaga socket with cap

Art. 70000613



MSLC205RG Luminaire controller + radar, Zhaga, 80 mm

Art. 70010027

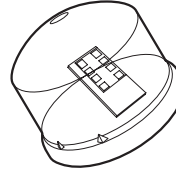

MSLC205RGL Luminaire controller, Zhaga, 80 mm

Art. 70010029

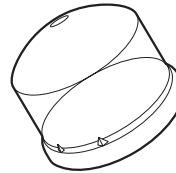

Connector

Art. 70000313

IP66 rated connector offers easy installation of the street luminaires.
3 wire cable connector

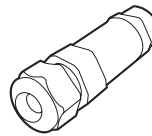

Connector

Art. 70000304

IP66 rated connector offers easy installation of the street luminaires.
5 wire cable connector

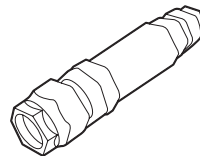

**Pre-installed cable sets
For internal power supply**

- 3 x 1,5 mm - 0,5 m long cable.....Art. 70000319
- 3 x 1,5 mm - 5 m long cable.....Art. 70000320
- 3 x 1,5 mm - 6 m long cable.....Art. 70000321
- 3 x 1,5 mm - 8 m long cable.....Art. 70000322
- 3 x 1,5 mm - 10 m long cable.....Art. 70000323
- 3 x 1,5 mm - 12 m long cable.....Art. 70000324
- 3 x 1,5 mm - 18 m long cable.....Art. 70000325
- 3 x 1,5 mm - 20 m long cable.....Art. 70000425
- 3 x 1,5 mm - 22 m long cable.....Art. 70000426
- 3 x 1,5 mm - 25 m long cable.....Art. 70000427
- 3 x 1,5 mm - 32 m long cable.....Art. 70000430
- 3 x 1,5 mm - 42 m long cable.....Art. 70000431
- 3 x 1,5 mm - 50 m long cable.....Art. 70000432

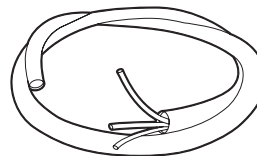

- 5 x 1,5 mm - 0,5 m long cable.....Art. 70000305
- 5 x 1,5 mm - 5 m long cable.....Art. 70000316
- 5 x 1,5 mm - 6 m long cable.....Art. 70000317
- 5 x 1,5 mm - 8 m long cable.....Art. 70000318
- 5 x 1,5 mm - 10 m long cable.....Art. 70000306
- 5 x 1,5 mm - 12 m long cable.....Art. 70000307
- 5 x 1,5 mm - 18 m long cable.....Art. 70000308
- 5 x 1,5 mm - 20 m long cable.....Art. 70000428
- 5 x 1,5 mm - 22 m long cable.....Art. 70000429
- 5 x 1,5 mm - 25 m long cable.....Art. 70000429
- 5 x 1,5 mm - 32 m long cable.....Art. 70000433
- 5 x 1,5 mm - 42 m long cable.....Art. 70000434
- 5 x 1,5 mm - 50 m long cable.....Art. 70000435

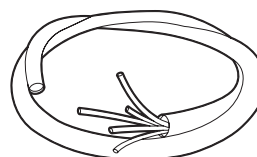

Certification



CE – conformity with European Union's health, safety and environmental protection standards

The CE mark is placed on products to state conformity with the relevant EU health, safety and environmental protection standards. In case of electronic products, the standards are, for example, the Restriction of Hazardous Substances in Electrical and Electronic Equipment (RoHS) directive, Waste Electrical and Electronic Equipment (WEEE) directive, the Electromagnetic Compatibility (EMC) directive etc. The mark ensures that the product can be sold anywhere in the European Economic Area (EEA).



UKCA - conformity with the relevant essential requirements of Great Britain

UKCA is a product mark intended to demonstrate compliance with the directives set by Great Britain (England, Scotland and Wales). It is analogous to the European Union's CE marking, meaning that depending on the type of product the applicable regulations are different. In case of LED lighting, the relevant requirements are compliance with the Electromagnetic Compatibility Regulations, the Electrical Equipment (Safety) Regulations, the Restriction of the Use of Certain Hazardous Substances in Electrical and Electronic Equipment Regulations and the Ecodesign for Energy-Related Products and Energy Information (Lighting Products) Regulations.



EAC - compliance with the regulations of the Eurasian Customs Union

The EAC Mark demonstrates conformity with all technical regulations defined by the Eurasian Customs Union. The conformity is assessed by an accredited independent testing laboratory. The EAC marking is a requirement in order to place a product on the market of Russia and the Eurasian Economic Union.



RoHS – compliance with European Union's RoHS directive

The RoHS (Restriction of Hazardous Substances in Electrical and Electronic Equipment) directive restricts (with exceptions) the use of ten hazardous materials in the manufacture of various types of electronic and electrical equipment. The aim of the directive is to prevent the risks posed to human health and the environment related to the management of electronic and electrical waste.



Zhaga-D4i - compliance with the requirements of Zhaga Book 18 or 20 and DALI standard

The Zhaga-D4i Mark represents the fact that a product is certified following the Zhaga-D4i joint certification program – a program established by Zhaga and the DALI Alliance (DiiA). The Zhaga part of the Mark represents that a product meets the requirements of Zhaga Book 18 or 20 – Zhaga standards that describe a smart interface between outdoor luminaires and sensing/ communication nodes. The DALI Alliance part of the Mark signifies that the product conforms with the DALI standard for intelligent, IoT-ready luminaires.



UL - compliance with UL standards for LED lighting **[Coming soon]**

UL stands for Underwriter Laboratories, a third-party certification company that's been around for over a century. UL sets industry-wide standards for products and performs testing according to these standards to ensure that the products marked with the UL mark are safe and high quality.



ENEC - compliance with European standards for electrical equipment

The ENEC Mark is the high quality European Mark for electrical equipment. It is governed by the European Testing Inspection Certification System which ensures that the testing of products is conducted at ENEC – accredited laboratories, following additional requirements regarding the testing procedures. The ENEC Mark means that the testing procedure was followed scrupulously and that the consumer can be certain of the product's safety and quality.



ENEC+ - compliance with European standards for LED – based electronic products

The ENEC+ Mark is the high quality European Mark for LED – based electronic products. It demonstrates the product's compliance with the IEC standards for performance of LED modules and LED based luminaires. The ENEC+ Mark can only be granted to a product that has already acquired the ENEC Mark.



DarkSky Approved - a DarkSky program seal of approval

DarkSky Approved certification is granted to outdoor lighting fixtures meeting the criteria outlined by DarkSky, an organization that aims to reduce light pollution, enabling clearer night skies and mitigating the impact on wildlife and human health. DarkSky Approved luminaires are shielded to cut off uplight, utilize energy-efficient light sources, and employ measures to limit glare. This certification reflects a dedication to responsible outdoor lighting, valued by communities, businesses, and individuals striving to protect nocturnal environments.



International EPD System – Environmental Product Declaration available

An Environmental Product Declaration (EPD) is a declaration of the materials, energy, transportation and other resources involved in the production, use and end-of life of a specific product. It is based on a Life Cycle Assessment (LCA) study that complies with standards EN ISO 14040 and EN ISO 14044. A product's EPD can help evaluate its impact on the environment and make sustainable choices.



Synergrid approved - compliance with Synergid requirements for LED lighting **[Coming soon]**

Synergrid is a federation of electricity and natural gas network operators in Belgium. The Synergrid approval mark means that the product is compliant with the design, safety and performance requirements set by Synergrid. The approval can be confirmed by checking the official list of Synergrid approved luminaires on the Synergrid website.

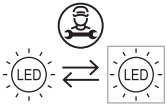

LED module replaceable by a professional

This pictogram shows that the LED modules included in the luminaire are only replaceable by a professional. This labeling is a requirement following the introduction of European Union's Regulation on energy labelling for light sources (EU) 2019/2015.

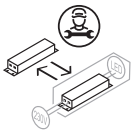

LED driver replaceable by a professional

This pictogram shows that the LED driver included in the luminaire is only replaceable by a professional. This labeling is a requirement following the introduction of European Union's Regulation on energy labelling for light sources (EU) 2019/2015.

References



↘
Riga,
Latvia



↘
Riga,
Latvia

VIZULO

Bukultu street 11
Riga, LV – 1005, Latvia

Sales: + 371 67 383 023
Production: + 371 67 383 024

sales@vizulo.com
www.vizulo.com

