

vizulo



Milzo Number 2

SUSPENDED

Milzo Number 2

suspended



RAL9016



RAL9006



RAL9005



SANDED
ALUMINIUM

Other colors
available on request

Milzo Number 2

suspended with sensor



RAL9016



RAL9006



RAL9005



SANDED
ALUMINIUM

Other colors
available on request

Milzo Number 2 with Microprism / Opal

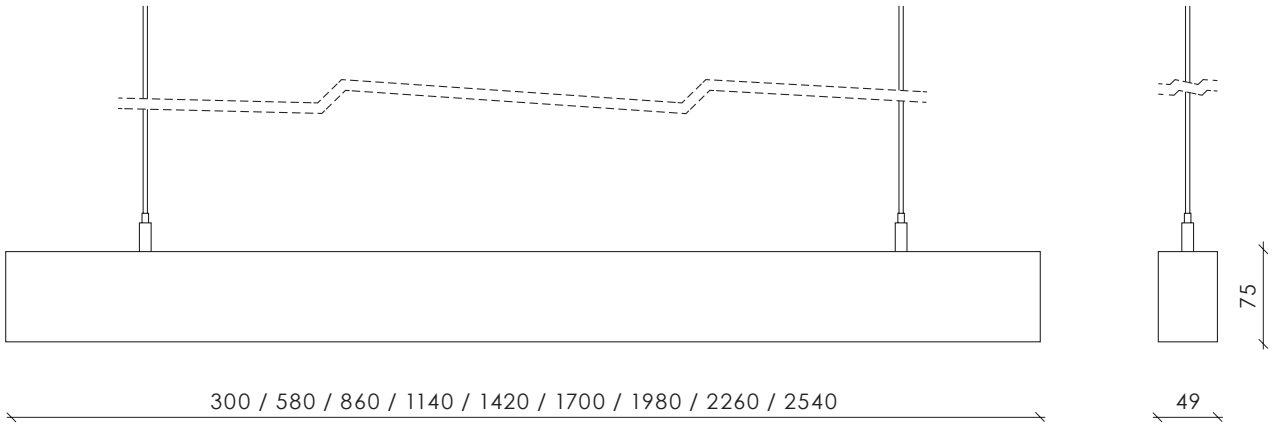

Milzo Number 2 with Optic / Shade

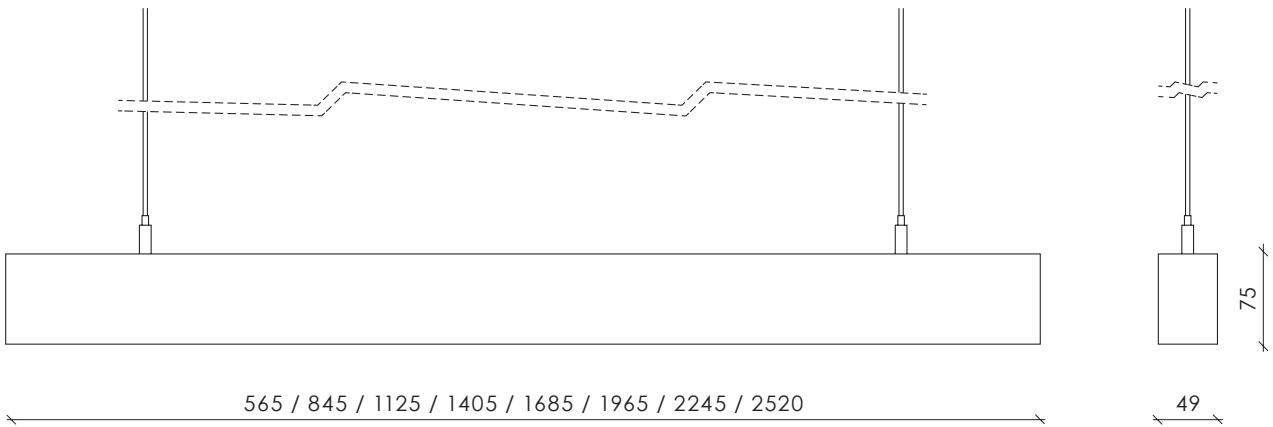

Applications



Office



Classroom

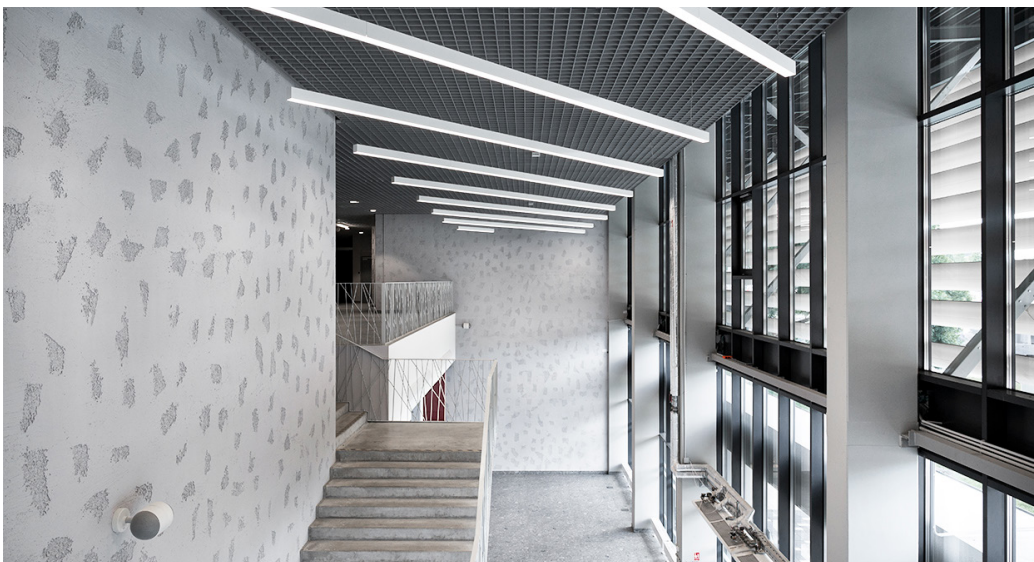

Common areas

Shade

Available in six different shades



↘ White gloss

According to model name principles

N2P □□□ □□□ □□□ **WG** □□□□ □□ □□□ □□□



↘ White matt

According to model name principles

N2P □□□ □□□ □□□ **WM** □□□□ □□ □□□ □□□



↘ Metal gloss

According to model name principles

N2P □□□ □□□ □□□ **MG** □□□□ □□ □□□ □□□



↘ Metal matt

According to model name principles

N2P □□□ □□□ □□□ **MT** □□□□ □□ □□□ □□□



↘ Black gloss

According to model name principles

N2P □□□ □□□ □□□ **BG** □□□□ □□ □□□ □□□



↘ Black matt

According to model name principles

N2P □□□ □□□ □□□ **BM** □□□□ □□ □□□ □□□

Technical information



V	220 - 240
Hz	50 - 60
W	12 - 90
lm	Up to 9290 ⁽¹⁾ Up to 12474 ⁽²⁾
lm/W	Up to 130 ⁽¹⁾ Up to 120 ⁽²⁾
K	3000 / 4000 ⁽³⁾
°C	+10 to +35
CRI	>80 / >90 / >95 ⁽⁴⁾ >90 / >95 ⁽⁵⁾

Body:	Aluminium profile
Dimming:	DALI / 1-10 V / Pull dimmer / Bluetooth / Non dimmable
Sensor:	PIR / PIR + Daylight
Initial chromaticity:	MacAdam 3
Lifetime:	100 000 h (L80B10) at Ta = 25 °C* 50 000 h (L90B10) at Ta = 25 °C*
Warranty:	5 years 2 years (emergency configuration)
Optics:	PMMA optic / PC shade
Uplight / Downlight:	Opal / Microprismatic
Mounting:	Suspended
Human Centric Lighting:	Available

¹⁾ For optic with shade

¹⁾ For microprismatic and opal

³⁾ Other CCT available on request

⁴⁾ Standard LED CRI

⁵⁾ Sun-Mimic LED CRI

* This value is only informative and may change according to selected article. LED Lifetime is strongly depending from LEDs current and junction temperature – increase in LED current and luminaire power lead to increase of junction temperature and as consequence lifetime decrease. Thus, luminaire models with lower power, lower current (and lower junction temperature) will have higher lifetime than standard models. And high power and high current luminaire models may have negative lifetime deviation comparing to standard models. To receive precise value please contact VIZULO export representatives.

Technical parameters for final product can differ from typical data by 7% due to special conditions of LED manufacturing processes.

Remarks

Surface version does not include Cable!
Standard cable length for Pendant version: 2.5 m

Possible Dimming combinations with sensors: No dimming + PIR sensor
No dimming + Daylight sensor
Pull dimmer + PIR sensor
Pull dimmer + Daylight sensor

Length-Power Tables with Microprism / Opal

Downlight

4000 K

Length, mm	300	580 / 640*	860 / 920*	1140 / 1200*	1420 / 1480*
Power, W	11 - 15	12 - 29	16 - 43	20 - 60	24 - 70
Luminous flux, lm	1 103 - 1 477	1 050 - 3 000	1 600 - 4 500	2 100 - 6 250	2 650 - 7 400

Length, mm	1700 / 1760*	1980 / 2040*	2260 / 2320*	2540 / 2600*
Power, W	25 - 80	29 - 90	33 - 96	62 - 116
Luminous flux, lm	3 150 - 8 650	3 700 - 9 850	4 200 - 10 500	7 490 - 12 474

Uplight

4000 K

Length, mm	580 / 640*	860 / 920*	1140 / 1200*	1420 / 1480*	1700 / 1760*
Power, W	12 - 20	16 - 30	20 - 40	24 - 50	25 - 60
Luminous flux, lm	1 050 - 2 200	1 600 - 3 300	2 100 - 4 500	2 650 - 5 700	3 150 - 6 850

Length, mm	1980 / 2040*	2260 / 2320*	2540 / 2600*
Power, W	29 - 70	33 - 80	62 - 90
Luminous flux, lm	3 700 - 8 000	4 200 - 9 250	7 490 - 10 200

Downlight + Uplight

4000 K

Length, mm	580 / 640*	860 / 920*	1140 / 1200*	1420 / 1480*	1700 / 1760*
Power, W	12 - 27	16 - 50	20 - 70	24 - 90	25 - 110
Luminous flux, lm	1 300 - 3 250	1 750 - 5 900	2 300 - 8 200	2 900 - 10 500	3 150 - 12 500

Length, mm	1980 / 2040*	2260 / 2320*	2540 / 2600*
Power, W	29 - 130	33 - 150	120 - 160
Luminous flux, lm	3 800 - 16 000	4 200 - 17 000	14 460 - 18 631

* With additional sensor or control system

Sensors

PIR Basic / DALI Basic / DALI Pro sensor (up to 5 m)*

Power Source:	DALI
Mounting height (H):	2 - 5 m
Detection range for PIR (max):	8 m (@H = 5 m)
Detection angle for PIR:	84°
Detection angle for light measurement:	30° - 60°
Light-control range:	0.5 - 2000 lux (adjustable)
Working temperature:	-20 ~ +50 °C **
Min. temperature difference between ambient temperature and detected object:	± 4 °C
Remote control (optional):	Set and control with IR remote control ***



Daylight sensor

Power Source:	220 - 240 V
DALI output devices:	10 / 32
DALI output:	2 Channels
Type:	Light and presence
Max. Detection area (Ø):	7 - 9 m
Max. installation height:	5 m
Presence detection angle:	40 - 90° (fixed or adjustable)
Light-control range:	10 - 800 lux
Hold-time:	User-definable
Working temperature:	-20 ~ +50 °C
Remote control (optional):	Set and control with IR remote control ***



* Available PIR sensor types:

- **Basic** - requires no external controller (no connection to external DALI network allowed);
- **Pro** - External controller required.

** Minimal Luminaire working temperature will be same or higher than for specific Sensors (if used)

*** Remote control can be ordered separately

Optics

Downlight

Linear optics with Microprism / Opal

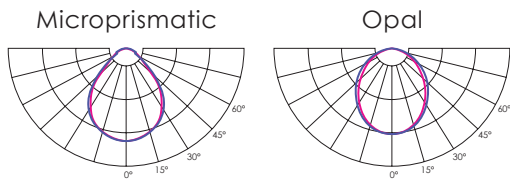

Linear optics with reflectors

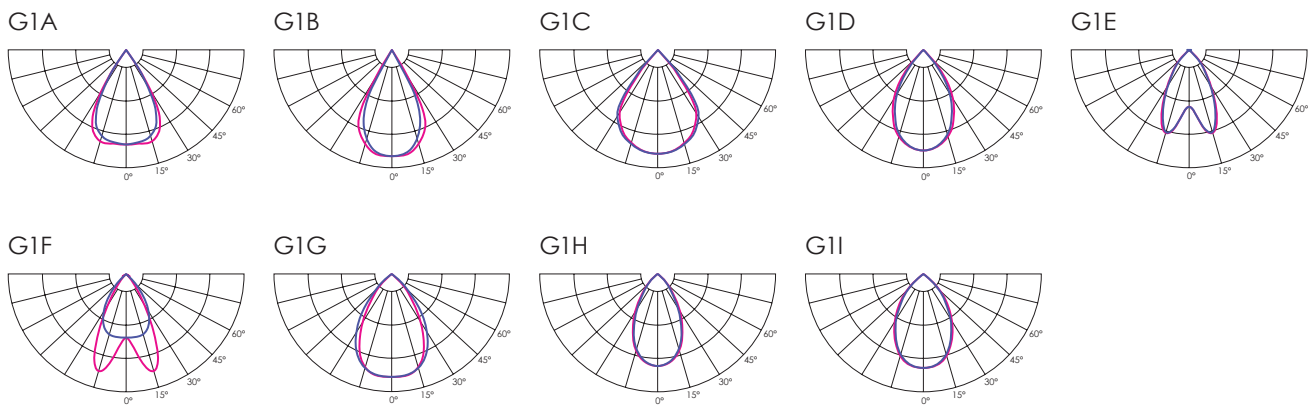

Uplight

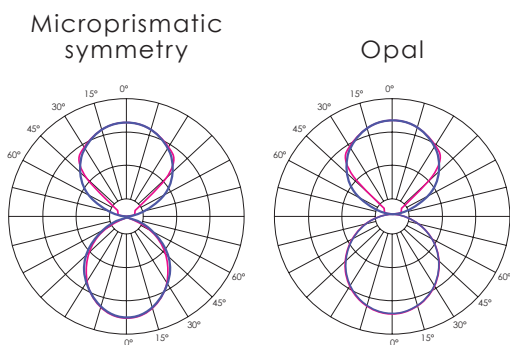

Emergency lighting

MILZO Number 2 has an option to have Emergency lighting (from 1200 mm)

Features

- Self contained emergency lighting
- 1 or 3 h rated duration
- Dimmable and non-dimmable versions available
- Constant power output
- Deepdischarge protection

While Mains voltage is present Emergency controller is also charging the connected battery. Rated emergency duration can be chosen (based on battery capacity) and can be 1 h or 3 h.

Operation

MILZO Number 2 luminaire which is equipped with Emergency lighting will work in 2 modes based on electrical conditions:

1. If Mains voltage is present, luminaire will work with its programmed power (just like in case without Emergency lighting)
2. If there is outage of Mains voltage, luminaire will work in Emergency mode with little power (about 2.5 W) while feeding from the battery

Simple wiring diagram

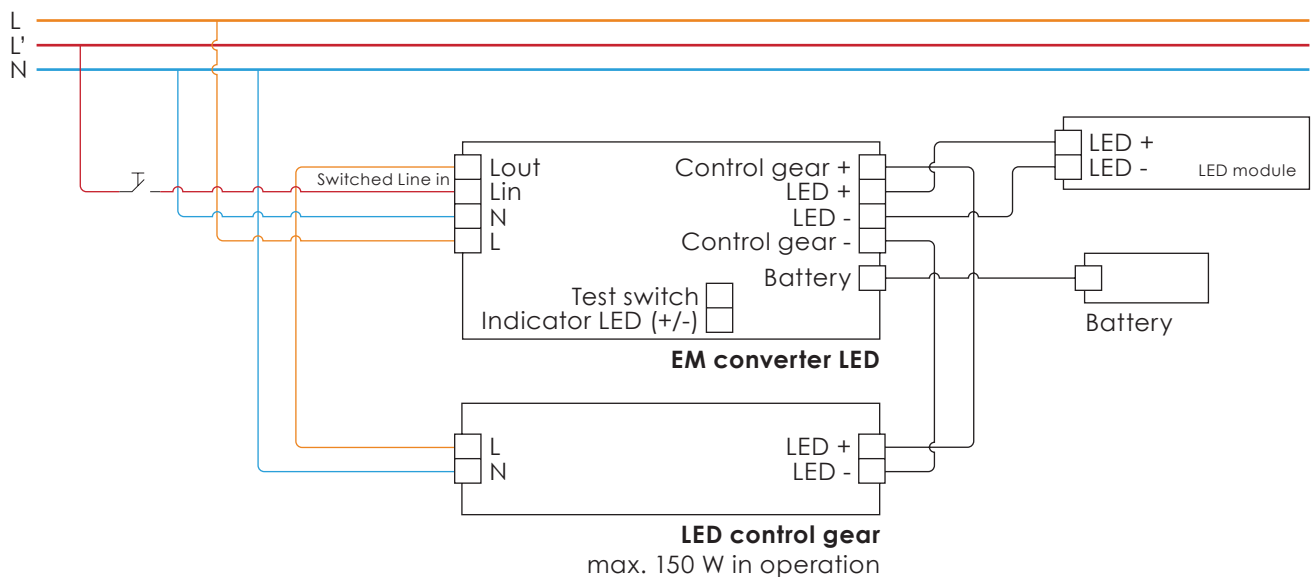

Additional Test switch

For connection to the emergency
For checking the device function

Status indication LED

Two-colour status display LED (bi-colour)
Green: system OK, Red: fault



Model name principles

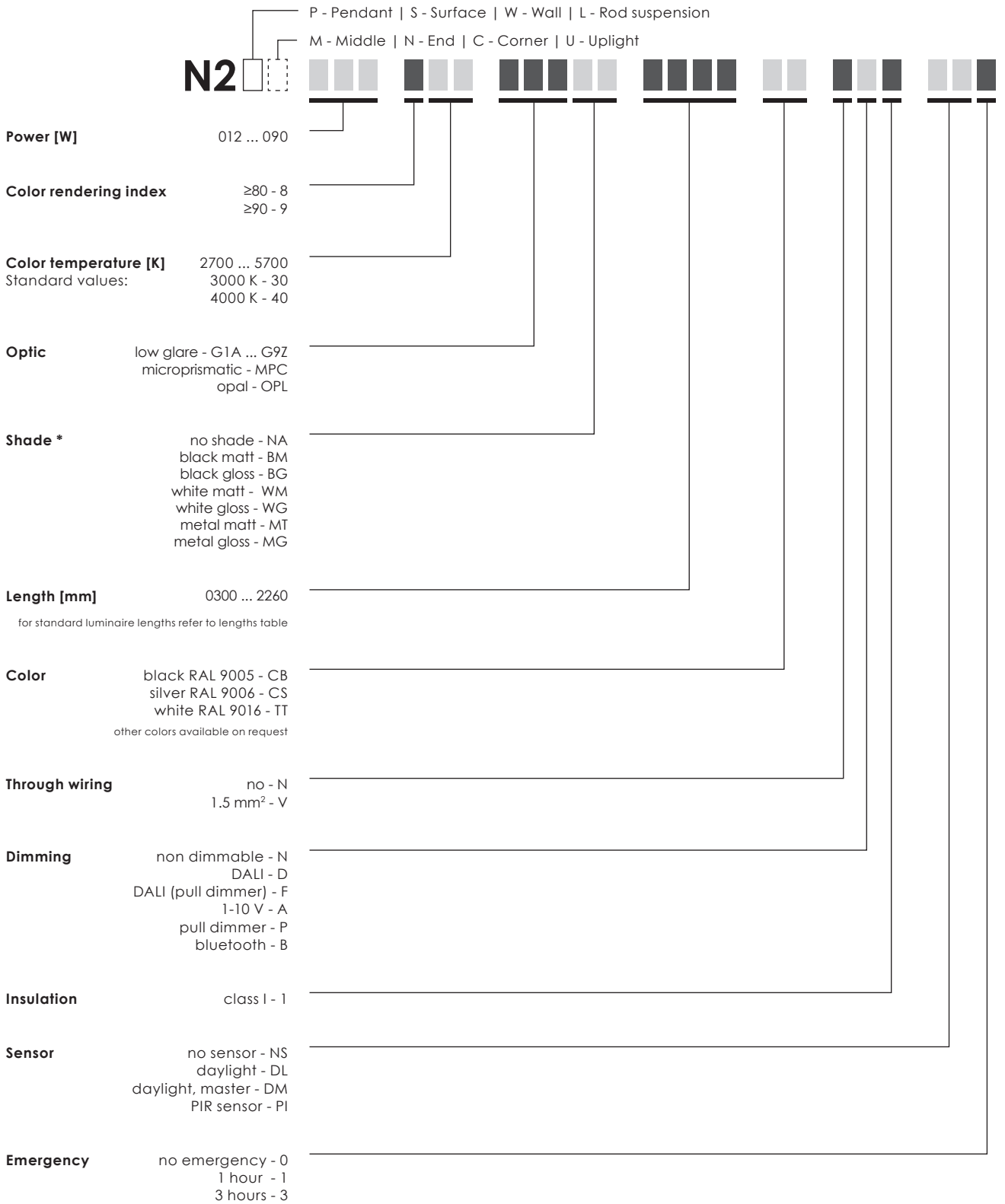

EXAMPLE N2P 090 830 MPCNA 2260 CB NN1 NS0

* Shade is only available with low glare optics

Accessories

Milzo Number 2 standard suspension, set for one fixing point, black

Art. 77112009

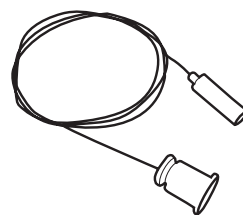

Connection cable 5x1.5 mm² (x2.5 m) with open end

Art. 70042016

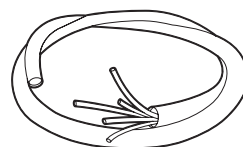

Connection cable 3x1.5 mm² (x2.5 m) with open end

Art. 70042018

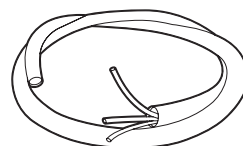

Black stranded PVC cable with black fabric

- RR27XN 2 x 0.75 mm² (x 2.5 m) Art. 70100160
- RR37XN 3 x 0.75 mm² (x 2.5 m) Art. 70100161
- RR47XN 4 x 0.75 mm² (x 2.5 m) Art. 70100162
- MV57XN 5 x 0.75 mm² (x 2.5 m) Art. 70100163

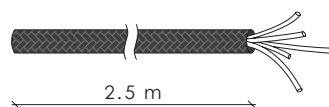

Cable with coloured fabric

Colours available on request:



**Connection cable 3x1.5 mm²
(x2.5 m) with plug**

Art. 70042022

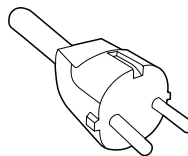

**Connection cable 5x1.5 mm²
(x2.5 m) with Ensto (NAC51S.W)
5-way plug**

Art. 70042009

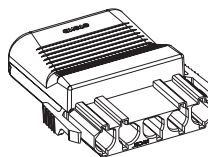

**Connection cable with DALI 5x1.5 mm²
(x2.5 m) with Wago Winsta (770-1115)
5-way plug**

Art. 70042030

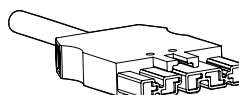

Plug 250 VAC 16A IP44 PE 3P

Art. 70000421

Ceiling box set, ND

RAL 9006 Art. 70056004
RAL 9016 Art. 70056015
RAL 9005 Art. 70056029

Ceiling box set, DALI

RAL 9006 Art. 70056007
RAL 9016 Art. 70056022
RAL 9005 Art. 70056030

Connection cable

White / halogen free / transparent

Fabric connection cable

White / black / red

Certification



CE – conformity with European Union's health, safety and environmental protection standards

The CE mark is placed on products to state conformity with the relevant EU health, safety and environmental protection standards. In case of electronic products, the standards are, for example, the Restriction of Hazardous Substances in Electrical and Electronic Equipment (RoHS) directive, Waste Electrical and Electronic Equipment (WEEE) directive, the Electromagnetic Compatibility (EMC) directive etc. The mark ensures that the product can be sold anywhere in the European Economic Area (EEA).



UKCA - conformity with the relevant essential requirements of Great Britain

UKCA is a product mark intended to demonstrate compliance with the directives set by Great Britain (England, Scotland and Wales). It is analogous to the European Union's CE marking, meaning that depending on the type of product the applicable regulations are different. In case of LED lighting, the relevant requirements are compliance with the Electromagnetic Compatibility Regulations, the Electrical Equipment (Safety) Regulations, the Restriction of the Use of Certain Hazardous Substances in Electrical and Electronic Equipment Regulations and the Ecodesign for Energy-Related Products and Energy Information (Lighting Products) Regulations.



RoHS – compliance with European Union's RoHS directive

The RoHS (Restriction of Hazardous Substances in Electrical and Electronic Equipment) directive restricts (with exceptions) the use of ten hazardous materials in the manufacture of various types of electronic and electrical equipment. The aim of the directive is to prevent the risks posed to human health and the environment related to the management of electronic and electrical waste.

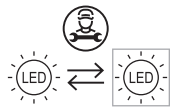

LED module replaceable by a professional

This pictogram shows that the LED modules included in the luminaire are only replaceable by a professional. This labeling is a requirement following the introduction of European Union's Regulation on energy labelling for light sources (EU) 2019/2015.

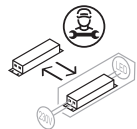

LED driver replaceable by a professional

This pictogram shows that the LED driver included in the luminaire is only replaceable by a professional. This labeling is a requirement following the introduction of European Union's Regulation on energy labelling for light sources (EU) 2019/2015.

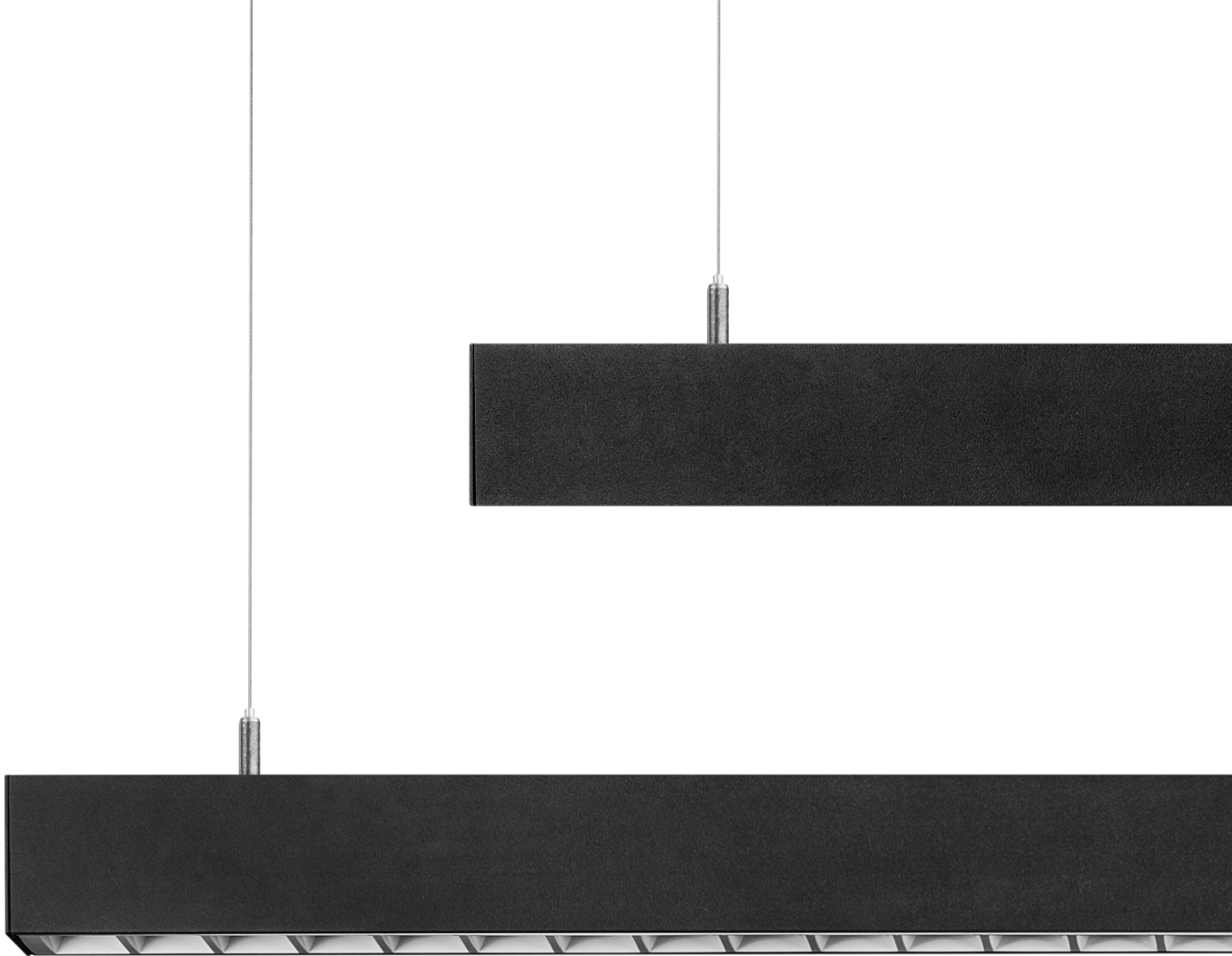

VIZULO

Bukultu street 11
Riga, LV – 1005, Latvia

Sales: + 371 67 383 023
Production: + 371 67 383 024

sales@vizulo.com
www.vizulo.com

 VIZULO

 VIZULOSOLUTIONS