

vizulo



MINI  
MARTIN



**Architectural & Landscape**

**Outdoor Industrial Area**

**Residential Street/Area**

**Ventilation cable gland**

Combines pressure equalization and cable gland in a single unit. It ensures high air flow rates as well as high water protection capacity

**Glass**

Flat glass. Glass is fixed to die-cast aluminium frame with screws

**LED module**

High quality LED's with optimal thermal resistance and energy consumption characteristic, for high lumen output and long expected life time. Color temperature available: 2700 K, 3000 K, 4000 K

*(1800 K, 2200 K, 3500 K, 5000 K, 5700 K, 6500 K available on customer request)*

**Sockets**

Zhaga and NEMA sockets compatible

**Protection**

IP66 for the complete luminaire

**Module temperature control**

The LED driver will start reducing the light output when the LED's approach critical temperature. The temperature is measured via a sensor placed on the PCB

*(function available on customer request)*

**Body**

Die-cast aluminium

**Lighting protection**

Built-in surge protection starting from 3 kV till 10 kV

**Light regulation**

MINI MARTIN drivers offer integrated midnight dimming and network-controlled 1-10 V and DALI protocols

**Impact resistance**

Up to IK10 (Vandal protected) for the complete luminaire



Traffic Roads

Pedestrian Roads

City Centre

## Midnight dimming

Midnight dimming provides multi-stage night-time power reduction based on an internal timer referenced to the power on/off time. There is no need for an external control infrastructure. The unit automatically performs a dimming profile based on the predefined scheduled reference to the midpoint, which is calculated based on the power on/off times.

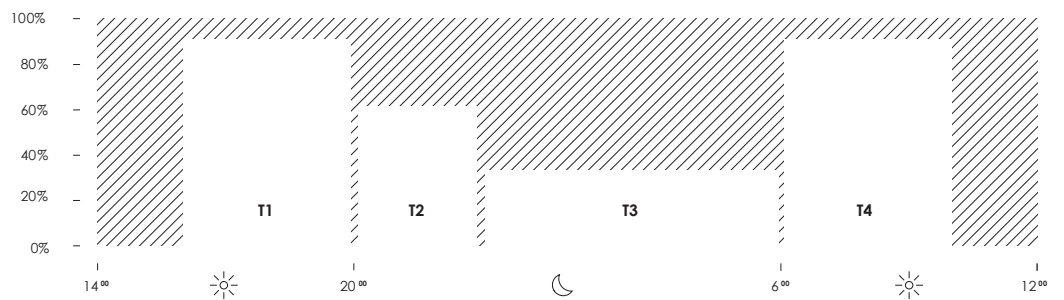

# Mini martin

with 60 mm console



**Note!** Glass with gray print is standard  
(black print glass on request!)



RAL7035



RAL9006



DB703



RAL9005

Other colors  
available on request

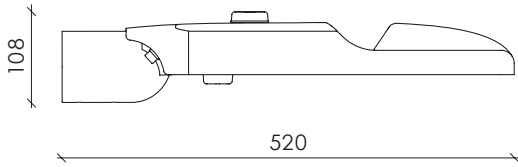
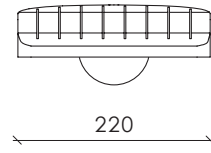
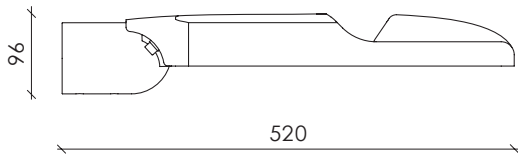

Dimensions with 2 Zhaga connectors

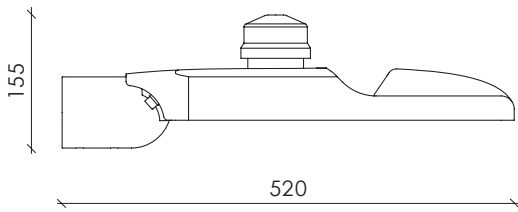

Dimensions with NEMA socket

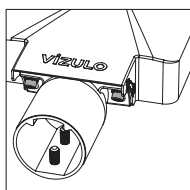
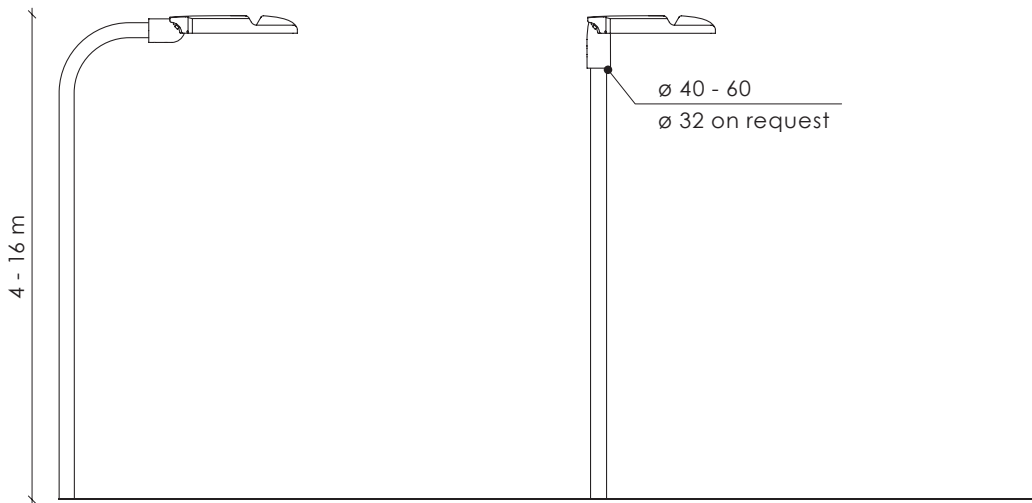

Horizontal entry  $\leq -20^\circ \dots 5^\circ$

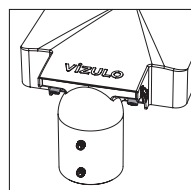
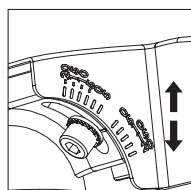

Vertical entry  $\leq 0^\circ \dots 20^\circ$

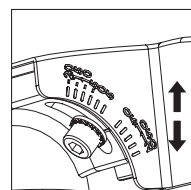

# Mini martin

with 60 mm adjustable console



**Note!** Glass with gray print is standard (black print glass on request!)



RAL7035



RAL9006



DB703



RAL9005

Other colors available on request

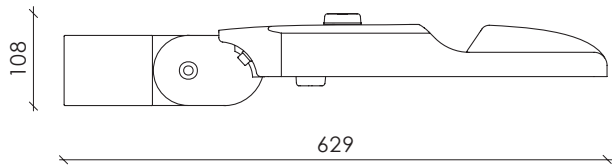
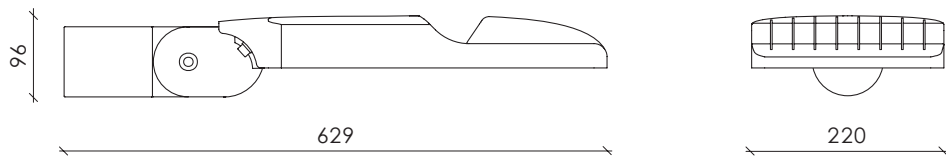

Dimensions with 2 Zhaga connectors

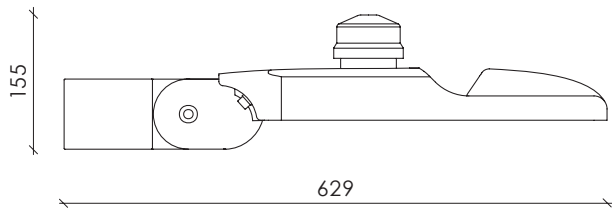

Dimensions with NEMA socket

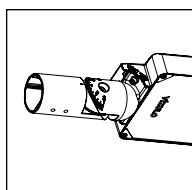
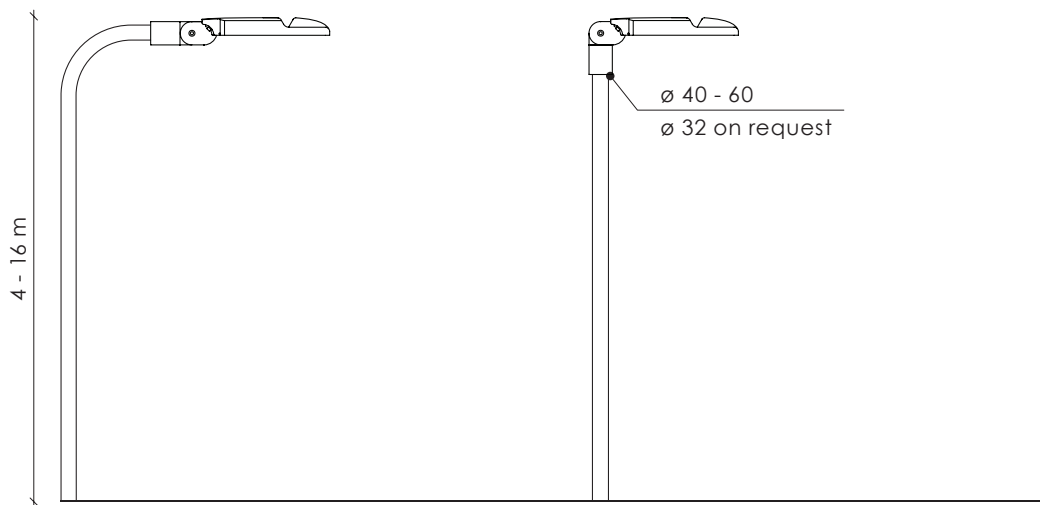

Horizontal entry  $\pm 90^\circ$

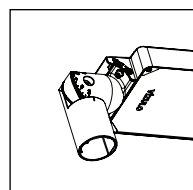
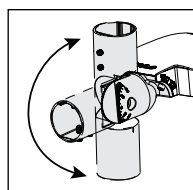

Vertical entry  $\pm 90^\circ$

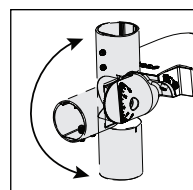

# Mini martin

with 76 mm adjustable console

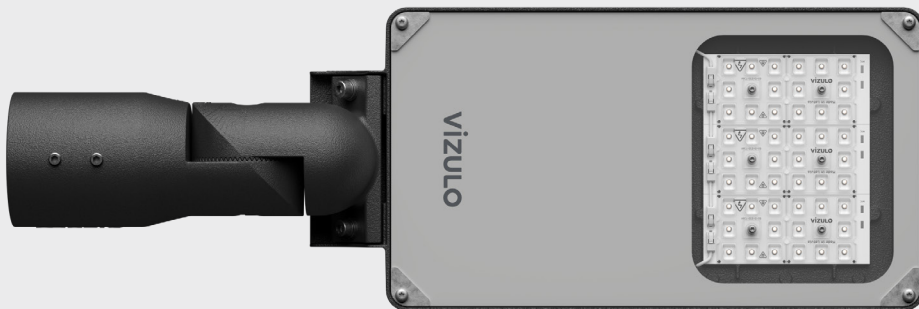

**Note!** Glass with gray print is standard  
(black print glass on request!)



RAL7035



RAL9006



DB703



RAL9005

Other colors  
available on request



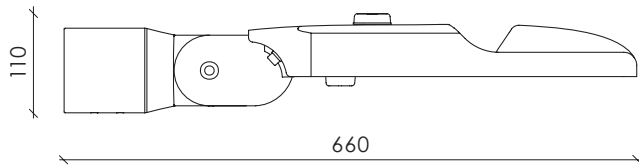
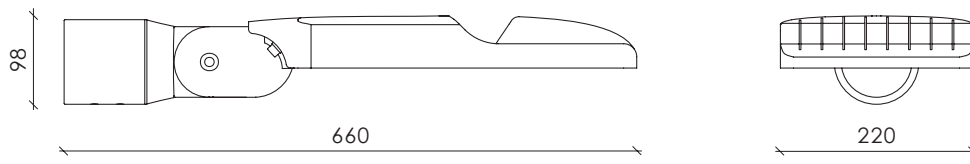

Dimensions with 2 Zhaga connectors

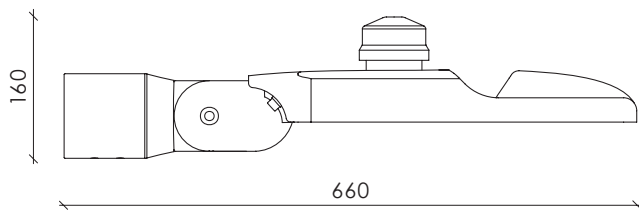

Dimensions with NEMA socket

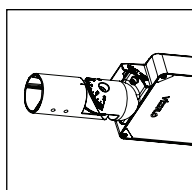
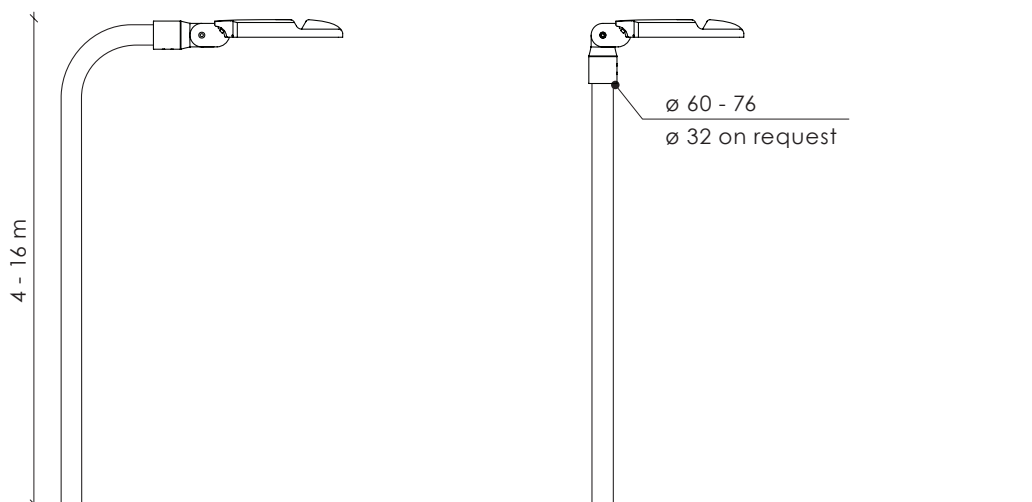

Horizontal entry  $\pm 90^\circ$

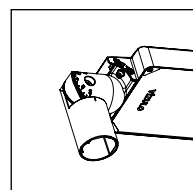
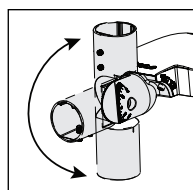

Vertical entry  $\pm 90^\circ$

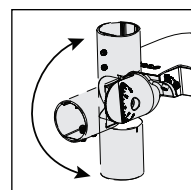

# Features

## ▾ SAFETY SWITCH

Safety first!  
Quick and safe maintenance of  
the opened luminaire by automatic  
disconnecting the mains supply

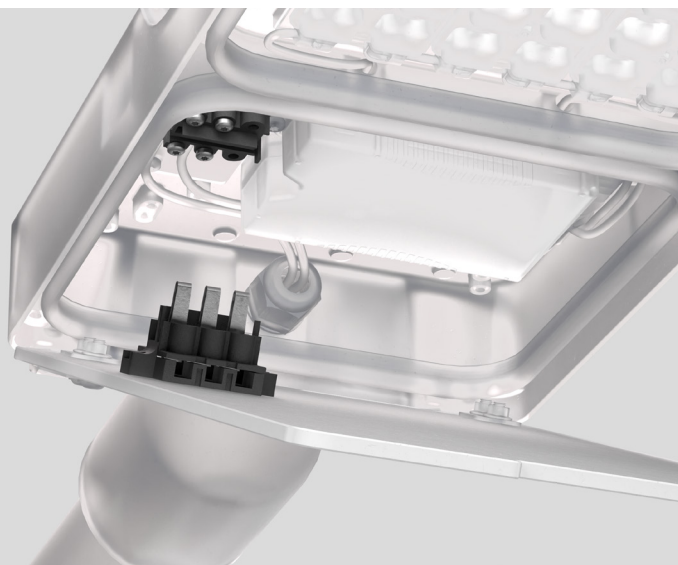

## ▾ ZHAGA UP AND DOWN

Connect up to 2 Zhaga  
Book 18 devices!  
Control luminaires and  
control motion on streets!



## Technical information



|             |   |
|-------------|---|
| <b>V</b>    | 198 - 264 / 110 - 277 <sup>(1)</sup>                  |
| <b>Hz</b>   | 50 - 60   |
| <b>W</b>    | 5 - 145   |
| <b>lm</b>   | 446 - 18 540 <sup>(2)</sup>                           |
| <b>lm/W</b> | 90 - 187 <sup>(3)</sup>                               |
| <b>K</b>    | 2700 / 3000 / 4000 /<br>TW 2700 - 6500 <sup>(4)</sup> |
| <b>°C</b>   | -40 up to +50 <sup>(5)</sup>                          |
| <b>CRI</b>  | >70 / >80 / >90 <sup>(4)</sup>                        |

|                                  |   |
|----------------------------------|---|
| <b>Body:</b>                     | Die-cast aluminium  |
| <b>Dimming:</b>                  | DALI / 1-10 V / Midnight dimming /<br>Step dimming / Mains dimming  |
| <b>Initial chromaticity:</b>     | MacAdam 5   |
| <b>Lifetime:</b>                 | Eco 100 000 h (L90B10) at Ta = 25 °C*<br>Standard 100 000 h (L98B10) at Ta = 25 °C*<br>High density 100 000 h (L98B10) at Ta = 25 °C* |
| <b>Warranty:</b>                 | 5 years   |
| <b>Installation:</b>             | Pre-wired cable 30 cm <sup>(6)</sup>  |
| <b>Spigot:</b>                   | 32 - 40 mm <sup>(7)</sup> / 40 - 60 mm / 60 - 76 mm   |
| <b>Socket:</b>                   | NEMA Top / Zhaga Top and Bottom   |
| <b>Intelligent Control:</b>      | Stand-alone / Group / CMS   |
| <b>Sensor:</b>                   | Motion / Motion + Daylight / Daylight   |
| <b>Surge protection:</b>         | 4 / 6 / 10 kV <sup>(8)</sup>  |
| <b>Corrosion protection:</b>     | Up to C5  |
| <b>Neto weight:</b>              | Up to 6.5 kg  |
| <b>Max. wind load area, SCd:</b> | 0.039 m <sup>2</sup>  |

<sup>1)</sup> Maximum operating voltage, ENEC certificate voltage 198 - 264 V, UL certificate voltage 110 - 277 V

<sup>2)</sup> Lumen output indicated at CRI > 70

<sup>3)</sup> This value depends from configuration and can reach even higher number when max efficient components are combined

<sup>4)</sup> 1800 / 2200 / 3500 / 5000 / 5700 / 6500 K available on request along with other not listed CRI and CCT

<sup>5)</sup> Operating temperature differs depending on chosen output wattage

<sup>6)</sup> Other lengths available on request

<sup>7)</sup> Achievable with an adapter for 40 - 60 mm spigot

<sup>8)</sup> 10 kV (L-N; L/N-PE) surge protection device available on request

<sup>9)</sup> Depending on the configuration. Please contact VIZULO export representatives for additional information

<sup>10)</sup> Coming soon

\*This value is only informative and may change according to selected article. LED Lifetime is strongly depending from LEDs current and junction temperature – increase in LED current and luminaire power lead to increase of junction temperature and as consequence lifetime decrease. Thus, luminaire models with lower power, lower current (and lower junction temperature) will have higher lifetime than standard models. And high power and high current luminaire models may have negative lifetime deviation comparing to standard models. To receive precise value please contact VIZULO export representatives.

Technical parameters for final product can differ from typical data by 7% due to special conditions of LED manufacturing processes.

## Standard modules

\* Data for L01 optic.

Check VIZULO members section for additional information

4000 K | CRI 70

| Number of LED's     | 4          |     |      | 8          |      |      | 12         |      |      |
|---------------------|------------|-----|------|------------|------|------|------------|------|------|
| Nominal current, mA | 270        | 500 | 730  | 140        | 540  | 700  | 280        | 500  | 670  |
| Power, W            | 5          | 8   | 11   | 5          | 15   | 19   | 12         | 20   | 26   |
| Luminous Flux, lm   | 520        | 920 | 1300 | 560        | 2000 | 2500 | 1650       | 2800 | 3550 |
| Efficacy, lm/W      | 104        | 115 | 118  | 112        | 133  | 132  | 138        | 140  | 137  |
| Power factor, PF    | Up to 0.93 |     |      | Up to 0.94 |      |      | Up to 0.97 |      |      |

| Number of LED's     | 16         |      |      | 24         |      |      |
|---------------------|------------|------|------|------------|------|------|
| Nominal current, mA | 280        | 500  | 680  | 260        | 470  | 700  |
| Power, W            | 15         | 25   | 35   | 20         | 35   | 52   |
| Luminous Flux, lm   | 2150       | 3630 | 5000 | 3060       | 5300 | 7300 |
| Efficacy, lm/W      | 143        | 145  | 143  | 153        | 151  | 140  |
| Power factor, PF    | Up to 0.97 |      |      | Up to 0.97 |      |      |

|                    |        |          |               |                |
|--------------------|--------|----------|---------------|----------------|
| Luminaire efficacy | 2700 K | 5 - 52 W | 446 - 6300 lm | 90 - 130 lm/W  |
|                    | 3000 K | 5 - 52 W | 490 - 6900 lm | 98 - 142 lm/W  |
|                    | 5000 K | 5 - 52 W | 520 - 7300 lm | 104 - 153 lm/W |
|                    | 5700 K | 5 - 52 W | 520 - 7300 lm | 104 - 153 lm/W |

## High density modules

\* Data for V01 optic.

Check VIZULO members section for additional information

4000 K | CRI 70

| Number of LED's     | 16         |      |      | 32         |      |       | 48         |       |       |       |
|---------------------|------------|------|------|------------|------|-------|------------|-------|-------|-------|
| Nominal current, mA | 280        | 480  | 760  | 290        | 500  | 760   | 270        | 815   | 940   | 975   |
| Power, W            | 15         | 25   | 39   | 29         | 50   | 75    | 40         | 120   | 140   | 145   |
| Luminous Flux, lm   | 2150       | 3540 | 5300 | 4600       | 7600 | 10600 | 6400       | 16425 | 18620 | 19110 |
| Efficacy, lm/W      | 143        | 142  | 136  | 159        | 152  | 141   | 160        | 137   | 133   | 132   |
| Power factor, PF    | Up to 0.98 |      |      | Up to 0.97 |      |       | Up to 0.99 |       |       |       |

|                    |        |            |                 |                |
|--------------------|--------|------------|-----------------|----------------|
| Luminaire efficacy | 2700 K | 15 - 145 W | 1850 - 16380 lm | 113 - 137 lm/W |
|                    | 3000 K | 15 - 145 W | 2000 - 18015 lm | 125 - 150 lm/W |
|                    | 5000 K | 15 - 145 W | 2150 - 19110 lm | 132 - 160 lm/W |
|                    | 5700 K | 15 - 145 W | 2150 - 19110 lm | 132 - 160 lm/W |

4000 K | CRI 70

| <b>Number of LED's</b>     | 8          |      |      | 16         |      |       | 24         |       |       |       |
|----------------------------|------------|------|------|------------|------|-------|------------|-------|-------|-------|
| <b>Nominal current, mA</b> | 290        | 475  | 700  | 270        | 480  | 710   | 265        | 750   | 865   | 895   |
| <b>Power, W</b>            | 15         | 25   | 38   | 28         | 50   | 75    | 40         | 120   | 140   | 145   |
| <b>Luminous Flux, lm</b>   | 2260       | 3600 | 5070 | 4250       | 7200 | 10000 | 6250       | 15780 | 17750 | 18230 |
| <b>Efficacy, lm/W</b>      | 151        | 144  | 133  | 152        | 144  | 133   | 156        | 132   | 127   | 126   |
| <b>Power factor, PF</b>    | Up to 0.98 |      |      | Up to 0.98 |      |       | Up to 0.99 |       |       |       |

|                    |        |            |                 |                |
|--------------------|--------|------------|-----------------|----------------|
| Luminaire efficacy | 2700 K | 15 - 145 W | 2100 - 16965 lm | 117 - 144 lm/W |
|                    | 3000 K | 15 - 145 W | 2170 - 17445 lm | 120 - 154 lm/W |
|                    | 5000 K | 15 - 145 W | 2240 - 18050 lm | 124 - 155 lm/W |
|                    | 5700 K | 15 - 145 W | 2210 - 17800 lm | 123 - 155 lm/W |

# Model name principles

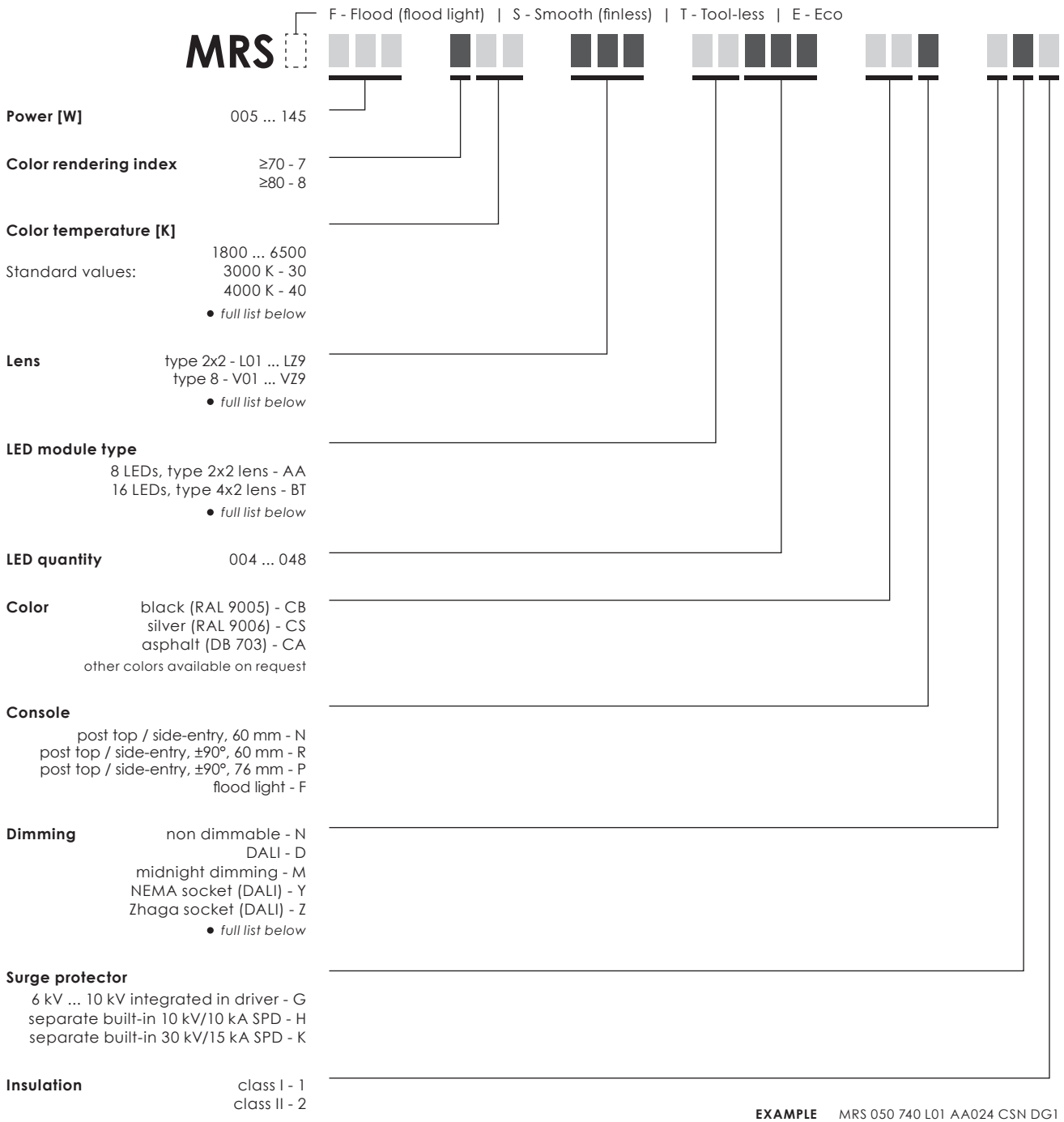

## • Full list of options

### Color temperature [K]

1800 ... 6500  
2700 K - 27  
3000 K - 30  
4000 K - 40  
Tunable White 2700-6500 - TW  
Nature Friendly Red - NR  
Nature Friendly Amber - NA  
Nature Friendly 1800 K - NK

### Lens

type 8 - V01 ... VZ9  
type 2x2 - L01 ... LZ9  
type 4x2 - B01 ... BZ9  
type 6x1 - T01 ... TZ9  
type 12 - Y01 ... YZ9  
type 1 - Z01 ... ZZ9  
custom configuration - M01 ... NZ9

### Dimming

non dimmable - N  
DALI - D  
1-10 V - A  
midnight dimming - M  
midnight dimming + DALI - R  
step dimming - S  
mains dimming - L  
wireless - W  
NEMA socket (DALI) - Y  
Zhaga socket (DALI) - Z  
\*custom configuration - X

### LED module type

8 LEDs, type 2x2 lens - AA  
16 LEDs, type 4x2 lens - BT  
16 LEDs, type 8 lens - AF  
8 LEDs, type 8 lens - BH  
4 LEDs, type 2x2 lens - BG

## \* CUSTOM CONFIGURATION EXAMPLE

NEMA socket + Zhaga socket; NEMA socket + Zhaga socket + midnight dimming; etc.  
Custom configuration information is available in order confirmation.

# LED modules

| Type | Max module quantity | Min LED quantity per module | Max LED quantity per module | Max LED quantity per luminaire | LED step | LED type        | Lens type             | Layout  |
|------|---------------------|-----------------------------|-----------------------------|--------------------------------|----------|-----------------|-----------------------|---|
| AA   | 3                   | 4                           | 8                           | 24                             | 2        | Standard<br>Eco | type 2x2<br>L01...LZ9 |  |
| AF   | 3                   | 4                           | 16                          | 48                             | 4        | Standard        | type 8<br>V01...VZ9   |  |
| BT   | 3                   | 4                           | 16                          | 48                             | 4        | Standard        | type 4x2<br>B01...BZ9 |  |

# Cable core count

| Socket | Dimming                 | Model number abbreviation | Input cable core count - Class I | Input cable core count - Class II |
|--------|-------------------------|---------------------------|----------------------------------|-----------------------------------|
| None   | None                    | N                         | 3                                | 2                                 |
| None   | DALI                    | D                         | 5                                | 4                                 |
| None   | Midnight dimming        | M                         | 3                                | 2                                 |
| None   | Midnight dimming + DALI | R                         | 5                                | 4                                 |
| None   | Step dimming            | S                         | 5 <sup>(1)</sup>                 | 4 <sup>(1)</sup>                  |
| None   | Mains dimming           | L                         | 3                                | 2                                 |
| Zhaga  | DALI                    | Z                         | 3 <sup>(2)</sup>                 | 2 <sup>(2)</sup>                  |
| Zhaga  | Midnight dimming        | X                         | 3                                | 2                                 |
| Zhaga  | Mains dimming           | X                         | 3                                | 2                                 |
| NEMA   | DALI                    | Y                         | 3 / 5 <sup>(3)</sup>             | 2 / 4 <sup>(3)</sup>              |
| NEMA   | Midnight dimming        | X                         | 3                                | 2                                 |
| NEMA   | Step dimming            | X                         | 5 <sup>(1)</sup>                 | 4 <sup>(1)</sup>                  |
| NEMA   | Mains dimming           | X                         | 3                                | 2                                 |

<sup>1)</sup> 1 core unused

<sup>2)</sup> DALI wires used only for internal connection between driver and Zhaga socket(s)

<sup>3)</sup> +2 cores for external DALI connection

# Optics

## Standard modules

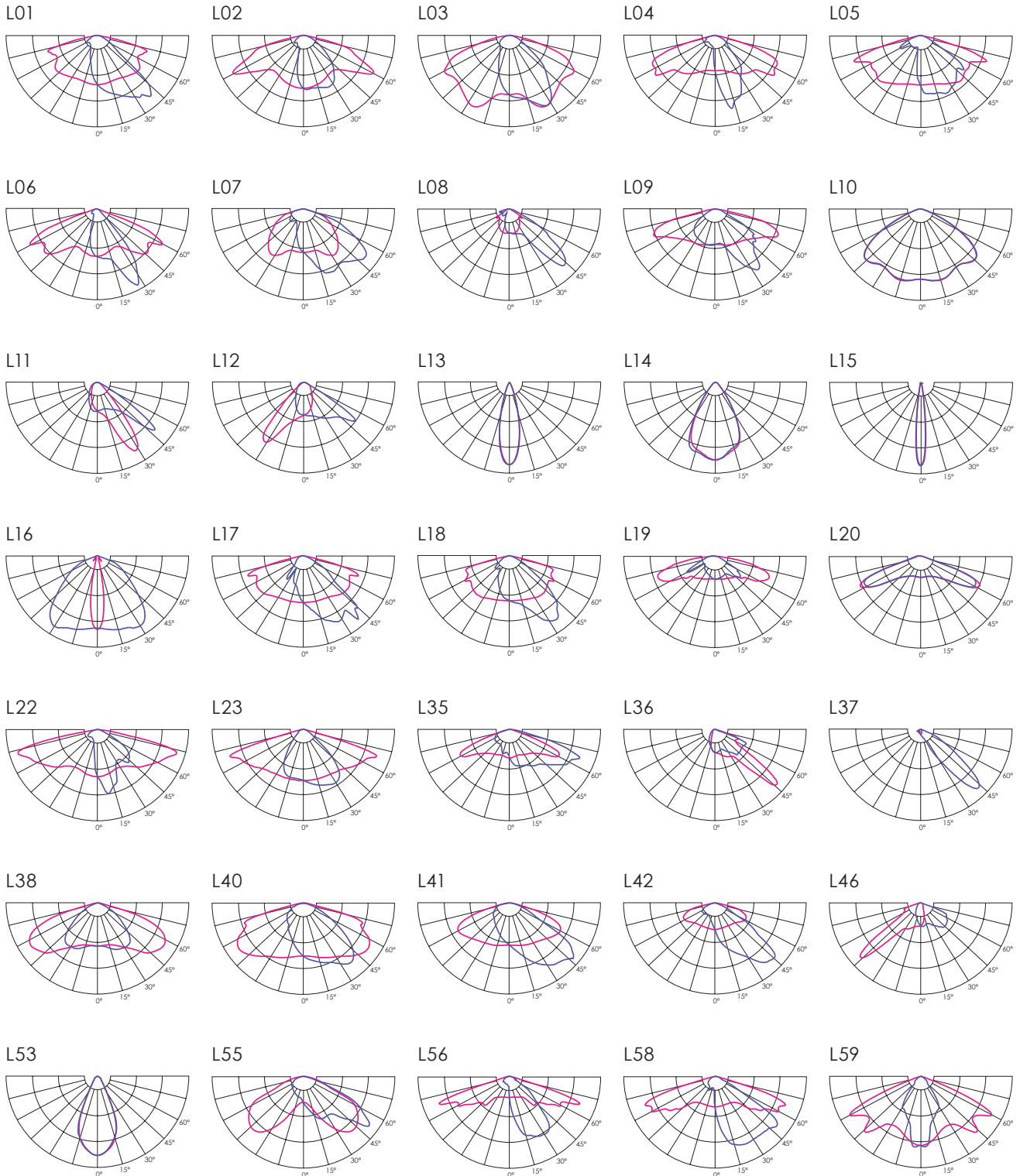



L60

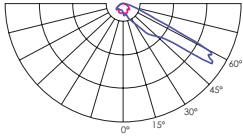

L61

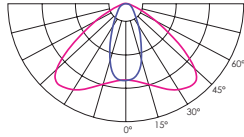

L62

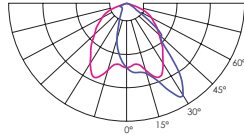

L63

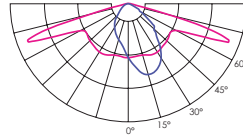

L64

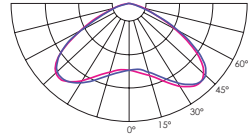

L65

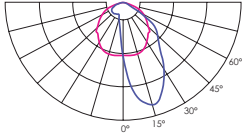

L66

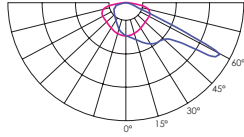

L67

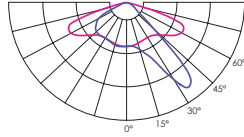

L68

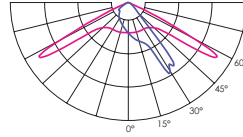

L76

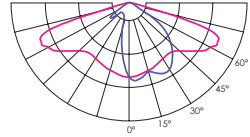

L77

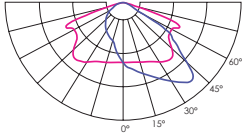

L78

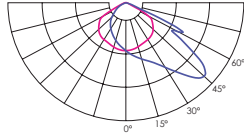

L79

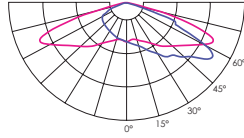

L80

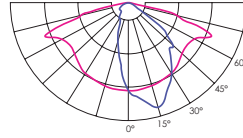

L88

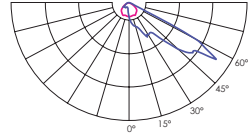

L90

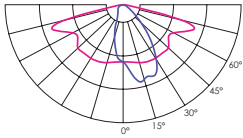

L94

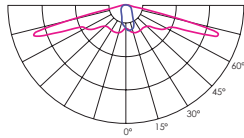

LB2

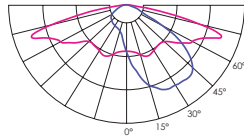

LB3

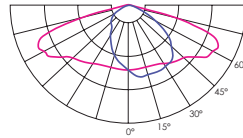

High density modules

V01

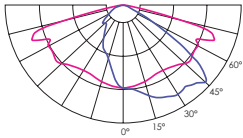

V04

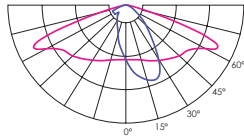

V05

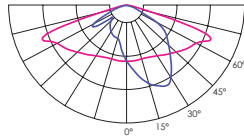

V10

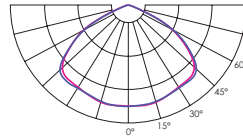

V13

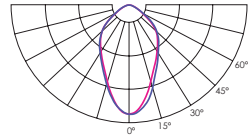

V16

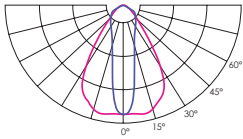

V20

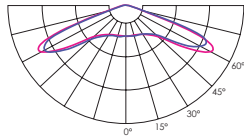

V22

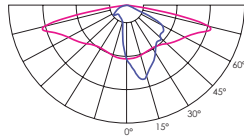

V35

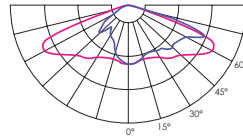

V45

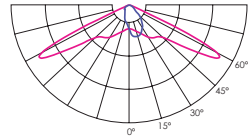

V52

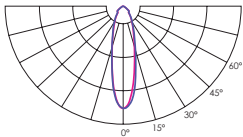

V53

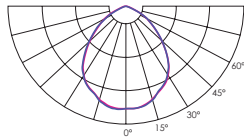

V57

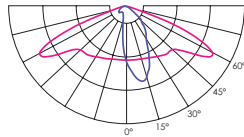



# Pedestrian crossing optics



|             |   |                                  |   |
|-------------|---|----------------------------------|---|
| <b>V</b>    | 198 - 264 / 110 - 277 <sup>(1)</sup>                      | <b>Body:</b>                     | Die-cast aluminium  |
| <b>Hz</b>   | 50 - 60   | <b>Dimming:</b>                  | DALI / 1-10 V / Midnight dimming / Step dimming / Mains dimming                     |
| <b>W</b>    | 5 - 52 <sup>(2)</sup><br>15 - 145 <sup>(3)</sup>          | <b>Initial chromaticity:</b>     | MacAdam 5   |
| <b>lm</b>   | Up to 7 300 <sup>(2)</sup><br>Up to 18 230 <sup>(3)</sup> | <b>Lifetime:</b>                 | Eco 100 000 h (L90B10) at Ta = 25 °C*<br>Standard 100 000 h (L98B10) at Ta = 25 °C* |
| <b>lm/W</b> | Up to 187 <sup>(4)</sup>                                  | <b>Warranty:</b>                 | 5 years   |
| <b>K</b>    | 2700 / 3000 / 4000 /<br>TW 2700 - 6500 <sup>(5)</sup>     | <b>Installation:</b>             | Pre-wired cable 30 cm <sup>(7)</sup>  |
| <b>°C</b>   | -40 up to +50 <sup>(6)</sup>                              | <b>Spigot:</b>                   | 32 - 40 mm <sup>(8)</sup> / 40 - 60 mm / 60 - 76 mm                                 |
| <b>CRI</b>  | >70 / >80 / >90 <sup>(5)</sup>                            | <b>Socket:</b>                   | NEMA Top / Zhaga Top and Bottom   |
|             |   | <b>Intelligent Control:</b>      | Stand-alone / Group / CMS   |
|             |   | <b>Sensor:</b>                   | Motion / Motion + Daylight / Daylight   |
|             |   | <b>Surge protection:</b>         | 4 / 6 / 10 kV <sup>(9)</sup>  |
|             |   | <b>Corrosion protection:</b>     | Up to C5  |
|             |   | <b>Neto weight:</b>              | Up to 6.5 kg  |
|             |   | <b>Max. wind load area, SCd:</b> | 0.039 m <sup>2</sup>  |

<sup>1)</sup> Maximum operating voltage, ENEC certificate voltage 198 - 264 V, UL certificate voltage 110 - 277 V

<sup>2)</sup> Standard modules, lumen output indicated at CRI > 70

<sup>3)</sup> ECO modules, lumen output indicated at CRI > 70

<sup>4)</sup> This value depends from configuration and can reach even higher number when max efficient components are combined

<sup>5)</sup> 1800 / 2200 / 3500 / 5000 / 5700 / 6500 K available on request along with other not listed CRI and CCT

<sup>6)</sup> Operating temperature differs depending on chosen output wattage

<sup>7)</sup> Other lengths available on request

<sup>8)</sup> Achievable with an adapter for 40 - 60 mm spigot

<sup>9)</sup> 10 kV (L-N; L/N-PE) surge protection device available on request

<sup>10)</sup> Depending on the configuration. Please contact VIZULO export representatives for additional information

<sup>11)</sup> Coming soon

\* This value is only informative and may change according to selected article. LED Lifetime is strongly depending from LEDs current and junction temperature – increase in LED current and luminaire power lead to increase of junction temperature and as consequence lifetime decrease. Thus, luminaire models with lower power, lower current (and lower junction temperature) will have higher lifetime than standard models. And high power and high current luminaire models may have negative lifetime deviation comparing to standard models. To receive precise value please contact VIZULO export representatives.

Technical parameters for final product can differ from typical data by 7% due to special conditions of LED manufacturing processes.

## Right side traffic

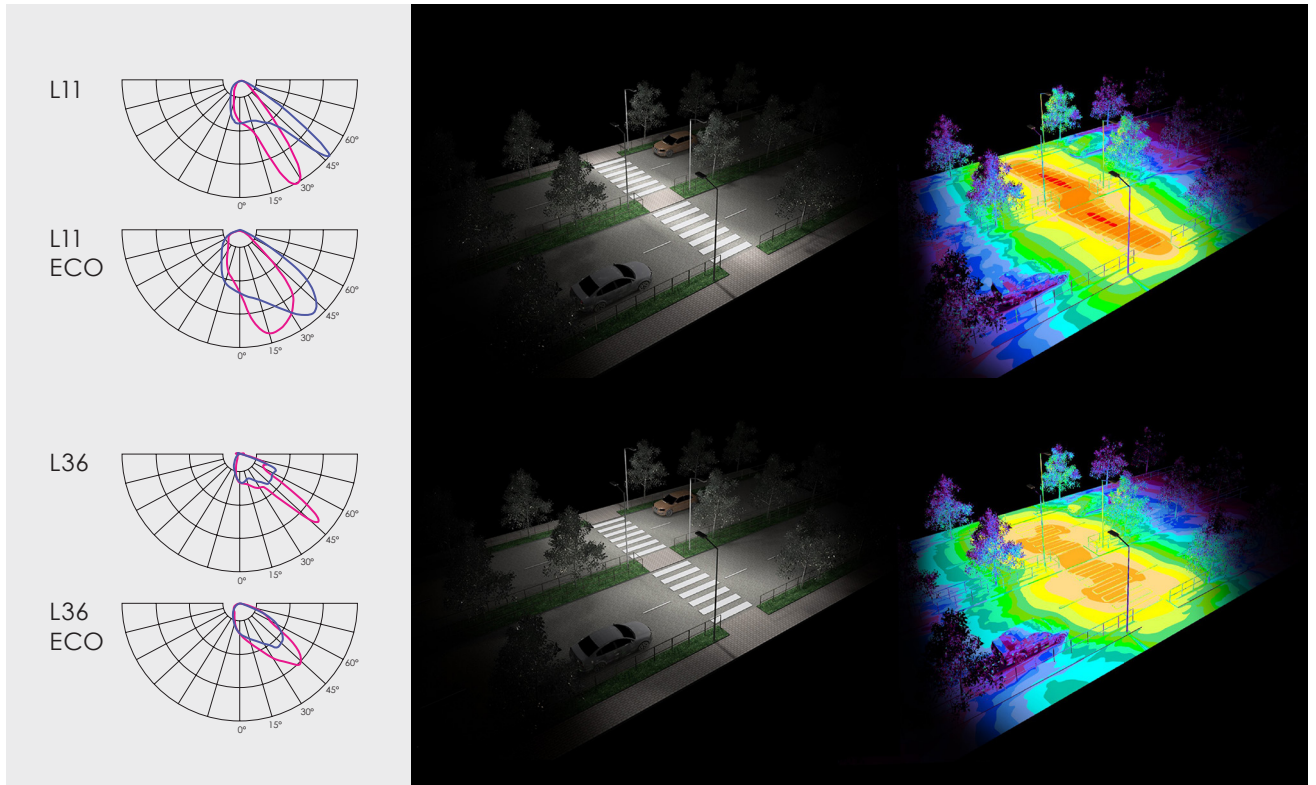

## Left side traffic

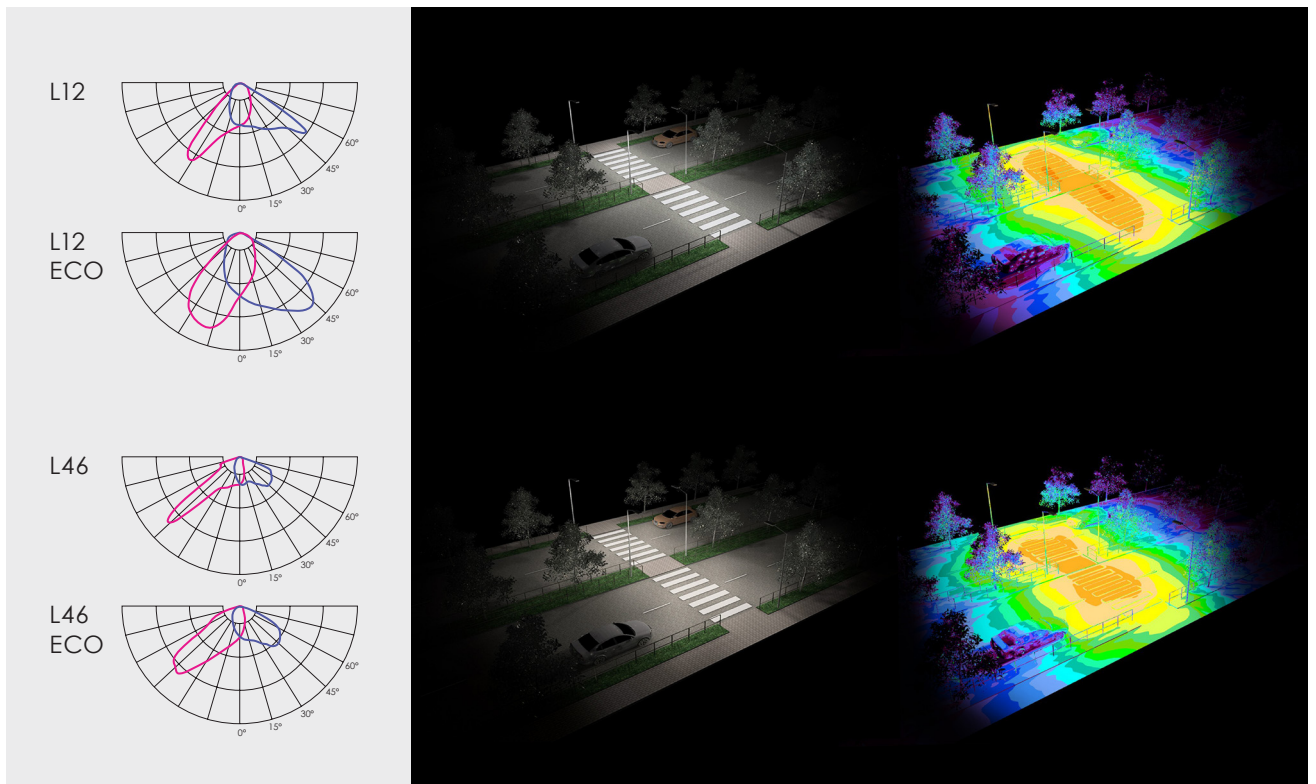

# Backlight cutter

## Backlight cutter | black

Art. 70000661

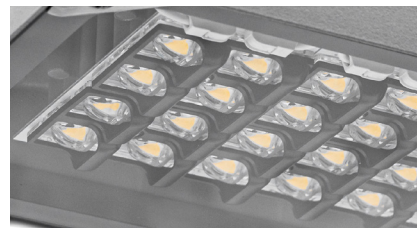

## Backlight cutter | white

Art. 70000662

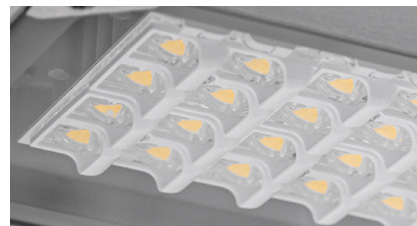

Optical losses from 10% to 31% depending from used optic.

Without backlight cutter

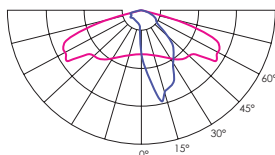

Backlight cutter | black

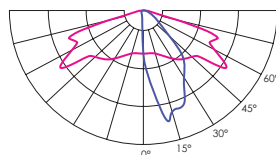

Backlight cutter | white

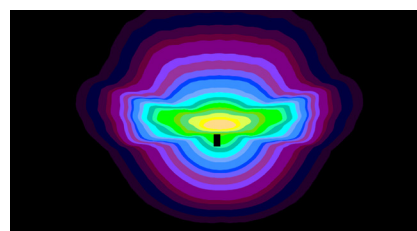
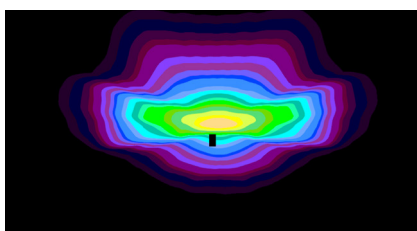
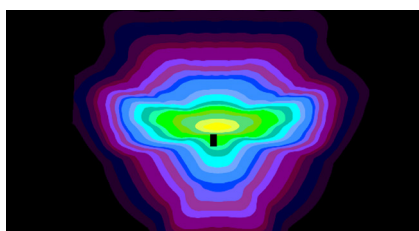
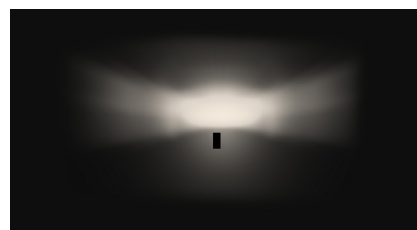
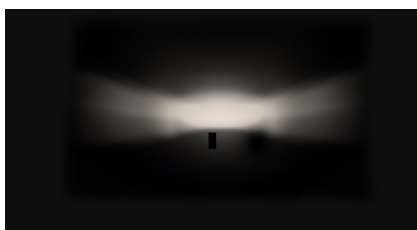
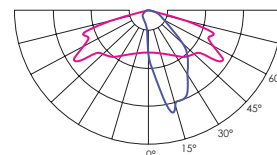

# Visors



**MRS back visor | silver (RAL9006)**

Art. 70055120

↘ Back visor



**MRS side visor | silver (RAL9006)**

Art. 70055121

↘ Back + side visors



**MRS front visor | silver (RAL9006)**

Art. 70055122

**MRS visor set | silver (RAL9006)**

Art. 70055131

↘ Visor set

# Accessories

## MAUGLO Segment controller

Art. 70010004

Segment Controller receives commands from MAUGLO server via GSM and transmits tasks to Luminaire Controller via radio frequency communication.

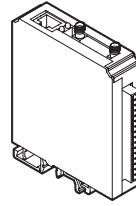

## MAUGLO Luminaire controller

Art. 70010001 / LC2M-23-05-R Luminaire Controller - 2 relays

Luminaire Controller is wireless mesh-networking device that uses 868 MHz for communication with Segment Controller and other Luminaire Controllers. It is delivered in various configurations to meet the needs of your applications.

Art. 70010002 / LC2M-12-05-R Luminaire Controller - 1 relay

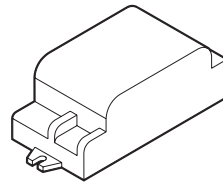

## MAUGLO Surge Protection device

Art. 70020001

Surge Protection device offers protection against lighting surges;

Voltage Protection level up (L-N)  $\leq 1,5$  kV

Voltage Protection level up (L/N-PE)  $\leq 2,0$  kV

$U_{oc} = 10$  kV

$I_{max} = 10$  kA

$I_{nom} = 5$  kA

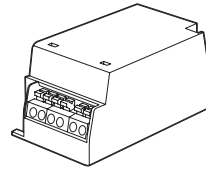

## Radio Frequency Antenna

Art. 70000108

Heavy duty IP67 enclosure  
Mounted in cabinet or luminaire body  
with 14 mm screw  
SMA connector



## NEMA Socket

2213362-3, 5 pin NEMA socket 105°C wires

Art. 70000362

2213362-4, 7 pin NEMA socket 105°C wires

Art. 70000333



## Dummy Link for NEMA Socket

Art. 70000113



## Zhaga socket no cap

Art. 70000612

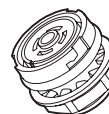

## Zhaga socket with cap

Art. 70000613

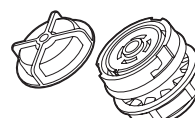

**MSLC205RG Luminaire controller + radar, Zhaga, 80 mm**

Art. 70010027

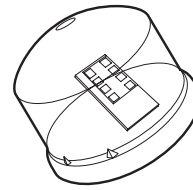

**MSLC205RGL Luminaire controller, Zhaga, 80 mm**

Art. 70010029

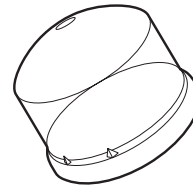

**Console adapter**

Spigot size 60 - 76 mm

Art. 70044002

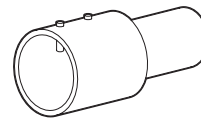

**Wall mounting bracket**

Spigot size 40 - 60 mm

Art. 70044001

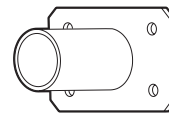

**Wall mounting bracket**

Vertical

Art. 70044004

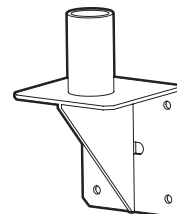

**Connector**

IP66 rated connector offers easy installation of the street luminaires.  
3 wire cable connector

Art. 70000313

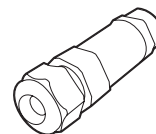

**Connector**

IP66 rated connector offers easy installation of the street luminaires.  
5 wire cable connector

Art. 70000304

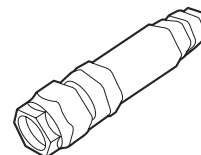

**Adjustable Console ±90°**

Art. 70055005

40 mm to 60 mm - Mini Martin / Micro Martin

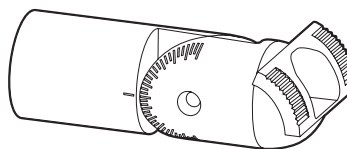

**Adjustable Console ±90°**

Art. 70055006

60 mm to 76 mm - Mini Martin / Micro Martin

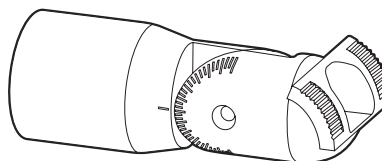

**Pre-installed cable sets  
For internal power supply**

|                                    |               |
|------------------------------------|---------------|
| 3 x 1,5 mm - 0,5 m long cable..... | Art. 70000319 |
| 3 x 1,5 mm - 5 m long cable.....   | Art. 70000320 |
| 3 x 1,5 mm - 6 m long cable.....   | Art. 70000321 |
| 3 x 1,5 mm - 8 m long cable.....   | Art. 70000322 |
| 3 x 1,5 mm - 10 m long cable.....  | Art. 70000323 |
| 3 x 1,5 mm - 12 m long cable.....  | Art. 70000324 |
| 3 x 1,5 mm - 18 m long cable.....  | Art. 70000325 |
| 3 x 1,5 mm - 20 m long cable.....  | Art. 70000425 |
| 3 x 1,5 mm - 22 m long cable.....  | Art. 70000426 |
| 3 x 1,5 mm - 25 m long cable.....  | Art. 70000427 |
| 3 x 1,5 mm - 32 m long cable.....  | Art. 70000430 |
| 3 x 1,5 mm - 42 m long cable.....  | Art. 70000431 |
| 3 x 1,5 mm - 50 m long cable.....  | Art. 70000432 |

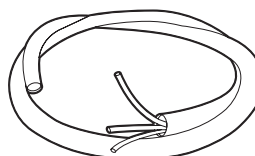

|                                    |               |
|------------------------------------|---------------|
| 5 x 1,5 mm - 0,5 m long cable..... | Art. 70000305 |
| 5 x 1,5 mm - 5 m long cable.....   | Art. 70000316 |
| 5 x 1,5 mm - 6 m long cable.....   | Art. 70000317 |
| 5 x 1,5 mm - 8 m long cable.....   | Art. 70000318 |
| 5 x 1,5 mm - 10 m long cable.....  | Art. 70000306 |
| 5 x 1,5 mm - 12 m long cable.....  | Art. 70000307 |
| 5 x 1,5 mm - 18 m long cable.....  | Art. 70000308 |
| 5 x 1,5 mm - 20 m long cable.....  | Art. 70000428 |
| 5 x 1,5 mm - 22 m long cable.....  | Art. 70000429 |
| 5 x 1,5 mm - 25 m long cable.....  | Art. 70000429 |
| 5 x 1,5 mm - 32 m long cable.....  | Art. 70000433 |
| 5 x 1,5 mm - 42 m long cable.....  | Art. 70000434 |
| 5 x 1,5 mm - 50 m long cable.....  | Art. 70000435 |





# Certification



**CE** – conformity with European Union's health, safety and environmental protection standards

The CE mark is placed on products to state conformity with the relevant EU health, safety and environmental protection standards. In case of electronic products, the standards are, for example, the Restriction of Hazardous Substances in Electrical and Electronic Equipment (RoHS) directive, Waste Electrical and Electronic Equipment (WEEE) directive, the Electromagnetic Compatibility (EMC) directive etc. The mark ensures that the product can be sold anywhere in the European Economic Area (EEA).



**UKCA** - conformity with the relevant essential requirements of Great Britain

UKCA is a product mark intended to demonstrate compliance with the directives set by Great Britain (England, Scotland and Wales). It is analogous to the European Union's CE marking, meaning that depending on the type of product the applicable regulations are different. In case of LED lighting, the relevant requirements are compliance with the Electromagnetic Compatibility Regulations, the Electrical Equipment (Safety) Regulations, the Restriction of the Use of Certain Hazardous Substances in Electrical and Electronic Equipment Regulations and the Ecodesign for Energy-Related Products and Energy Information (Lighting Products) Regulations.



**EAC** - compliance with the regulations of the Eurasian Customs Union

The EAC Mark demonstrates conformity with all technical regulations defined by the Eurasian Customs Union. The conformity is assessed by an accredited independent testing laboratory. The EAC marking is a requirement in order to place a product on the market of Russia and the Eurasian Economic Union.



**RoHS** – compliance with European Union's RoHS directive

The RoHS (Restriction of Hazardous Substances in Electrical and Electronic Equipment) directive restricts (with exceptions) the use of ten hazardous materials in the manufacture of various types of electronic and electrical equipment. The aim of the directive is to prevent the risks posed to human health and the environment related to the management of electronic and electrical waste.



**Zhaga-D4i** - compliance with the requirements of Zhaga Book 18 or 20 and DALI standard

The Zhaga-D4i Mark represents the fact that a product is certified following the Zhaga-D4i joint certification program – a program established by Zhaga and the DALI Alliance (DiiA). The Zhaga part of the Mark represents that a product meets the requirements of Zhaga Book 18 or 20 – Zhaga standards that describe a smart interface between outdoor luminaires and sensing/ communication nodes. The DALI Alliance part of the Mark signifies that the product conforms with the DALI standard for intelligent, IoT-ready luminaires.



**UL** - compliance with UL standards for LED lighting **[Coming soon]**

UL stands for Underwriter Laboratories, a third-party certification company that's been around for over a century. UL sets industry-wide standards for products and performs testing according to these standards to ensure that the products marked with the UL mark are safe and high quality.



**ENEC** - compliance with European standards for electrical equipment

The ENEC Mark is the high quality European Mark for electrical equipment. It is governed by the European Testing Inspection Certification System which ensures that the testing of products is conducted at ENEC – accredited laboratories, following additional requirements regarding the testing procedures. The ENEC Mark means that the testing procedure was followed scrupulously and that the consumer can be certain of the product's safety and quality.



**ENEC+** - compliance with European standards for LED – based electronic products

The ENEC+ Mark is the high quality European Mark for LED – based electronic products. It demonstrates the product's compliance with the IEC standards for performance of LED modules and LED based luminaires. The ENEC+ Mark can only be granted to a product that has already acquired the ENEC Mark.



**International EPD System** – Environmental Product Declaration available

An Environmental Product Declaration (EPD) is a declaration of the materials, energy, transportation and other resources involved in the production, use and end-of life of a specific product. It is based on a Life Cycle Assessment (LCA) study that complies with standards EN ISO 14040 and EN ISO 14044. A product's EPD can help evaluate its impact on the environment and make sustainable choices.



**LED module replaceable by a professional**

This pictogram shows that the LED modules included in the luminaire are only replaceable by a professional. This labeling is a requirement following the introduction of European Union's Regulation on energy labelling for light sources (EU) 2019/2015.



**LED driver replaceable by a professional**

This pictogram shows that the LED driver included in the luminaire is only replaceable by a professional. This labeling is a requirement following the introduction of European Union's Regulation on energy labelling for light sources (EU) 2019/2015.

# References



↘  
Sumarlidabaer  
Horse Farm,  
Iceland



↘  
Zwolle,  
Netherlands

## VIZULO

Bukultu street 11  
Riga, LV – 1005, Latvia

Sales: + 371 67 383 023  
Production: + 371 67 383 024

[sales@vizulo.com](mailto:sales@vizulo.com)  
[www.vizulo.com](http://www.vizulo.com)



VIZULO



VIZULOSOLUTIONS

