

vizulo



STORK
LITTLE BROTHER

Architectural & Landscape

Outdoor Industrial Area

Decorative & Urban Area

Residential Street/Area

Ventilation cable gland

Combines pressure equalization and cable gland in a single unit. It ensures high air flow rates as well as high water protection capacity

Glass

Flat glass. Glass is fixed to die-cast aluminium frame with metal clips and can easily be replaced

LED module

High quality LED's with optimal thermal resistance and energy consumption characteristic, for high lumen output and long expected life time. Color temperature available: 2700 K, 3000 K, 4000 K
(1800 K, 2200 K, 3500 K, 5000 K, 5700 K, 6500 K available on customer request)

Sockets

Zhaga and NEMA sockets compatible

Protection

IP66 for the complete luminaire

Impact resistance

IK10 (Vandal protected)
for the complete luminaire

Module temperature control

The LED driver will start reducing the light output when the LED's approach critical temperature. The temperature is measured via a sensor placed on the PCB
(function available on customer request)

Body

Die-cast aluminium

Lighting protection

Built-in surge protection starting from 3 kV till 10 kV

Light regulation

STORK LITTLE BROTHER drivers offer integrated midnight dimming and network-controlled 1-10 V and DALI protocols

Opening

Die-cast aluminium clip for tool-less opening or closing, fixed to the frame with stainless steel spring for easy maintenance

Safety switch

Safety switch disconnects power on opening



Traffic Roads

Pedestrian Roads

City Centre

Parks, Urban and Decorative Areas

Midnight dimming

Midnight dimming provides multi-stage night-time power reduction based on an internal timer referenced to the power on/off time. There is no need for an external control infrastructure. The unit automatically performs a dimming profile based on the predefined scheduled reference to the midpoint, which is calculated based on the power on/off times.

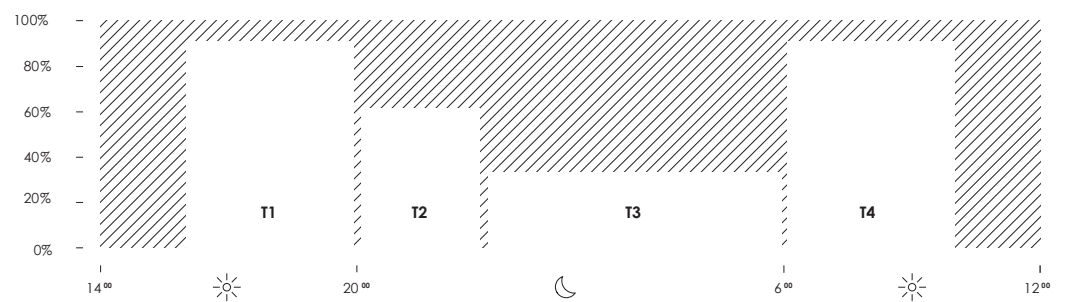

Stork little brother

with 60 mm console

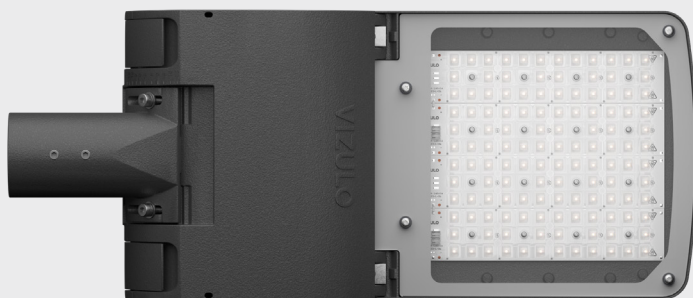

Note! Glass with gray print is standard
(black print glass on request!)



RAL7035



RAL9006



DB703



RAL9005

Other colors
available on request

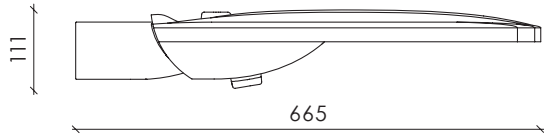
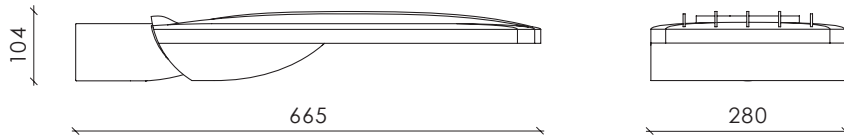

Dimensions with 2 Zhaga connectors

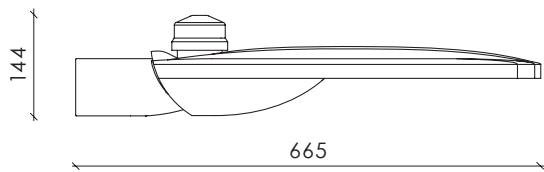

Dimensions with NEMA socket

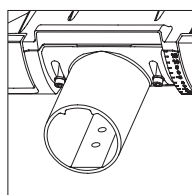
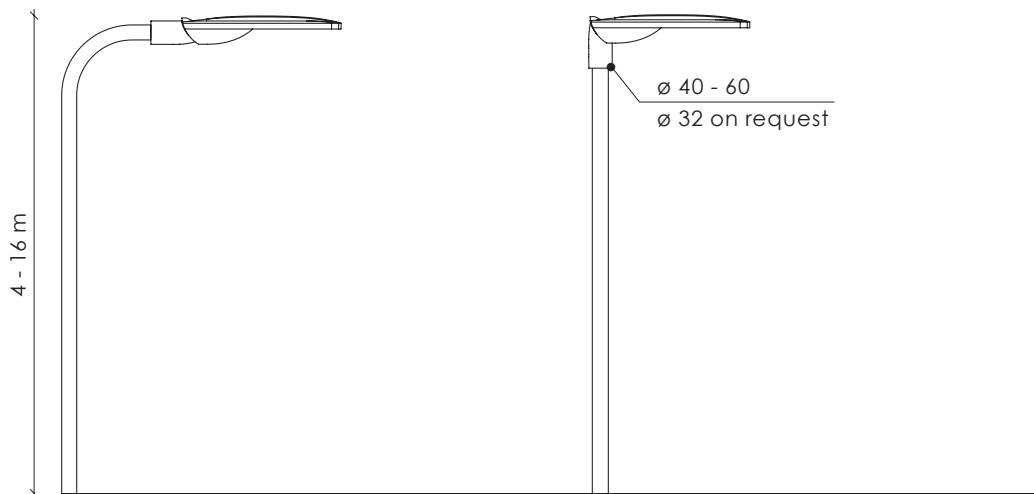

Horizontal entry $\leq -20^\circ \dots 5^\circ$

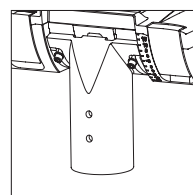
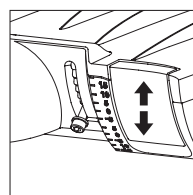

Vertical entry $\leq -5^\circ \dots 20^\circ$

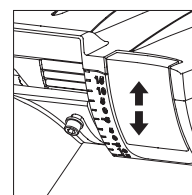

Note! Only those models with fixed mounting position (0° relative to the ground) are DarkSky approved!

Stork little brother

with 76 mm console



Note! Glass with gray print is standard
(black print glass on request!)



RAL7035



RAL9006



DB703



RAL9005

Other colors
available on request

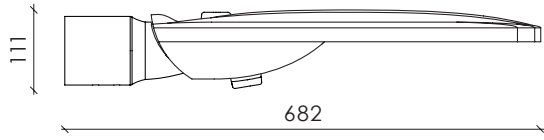
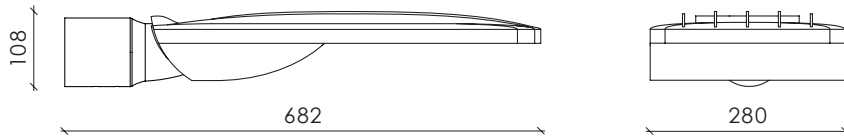

Dimensions with 2 Zhaga connectors

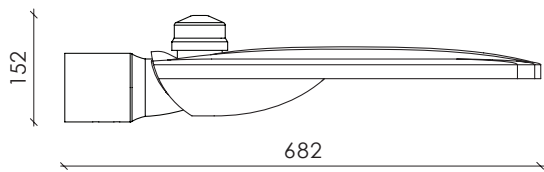

Dimensions with NEMA socket

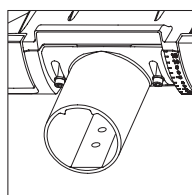
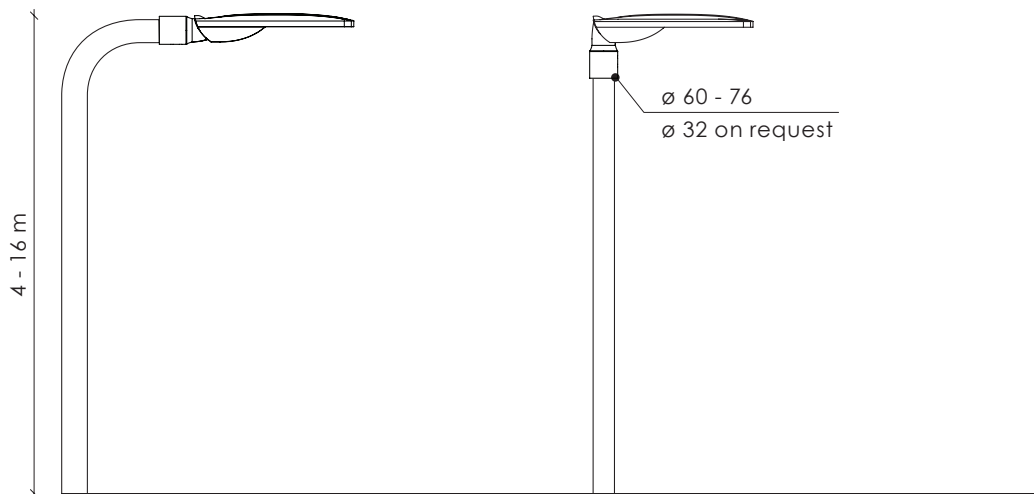

Horizontal entry $\leq -20^\circ \dots 5^\circ$

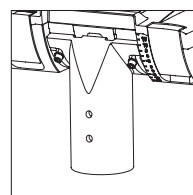
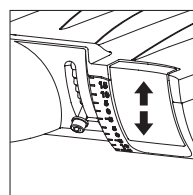

Vertical entry $\leq -5^\circ \dots 20^\circ$

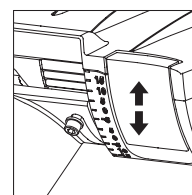

Note! Only those models with fixed mounting position (0° relative to the ground) are DarkSky approved!

Stork little brother

with 60 mm adjustable console

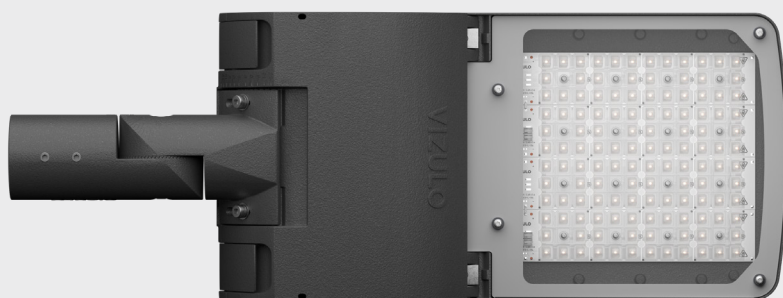

Note! Glass with gray print is standard
(black print glass on request!)



RAL7035



RAL9006



DB703



RAL9005

Other colors
available on request

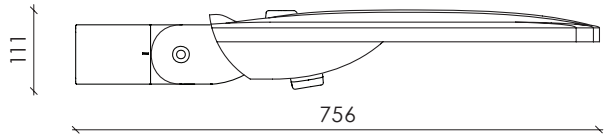
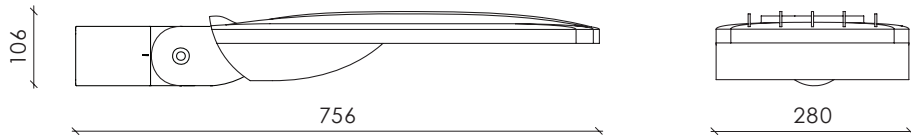

Dimensions with 2 Zhaga connectors

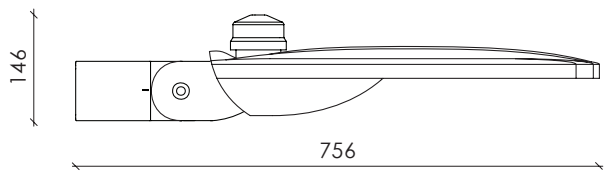

Dimensions with NEMA socket

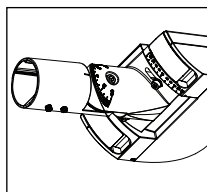
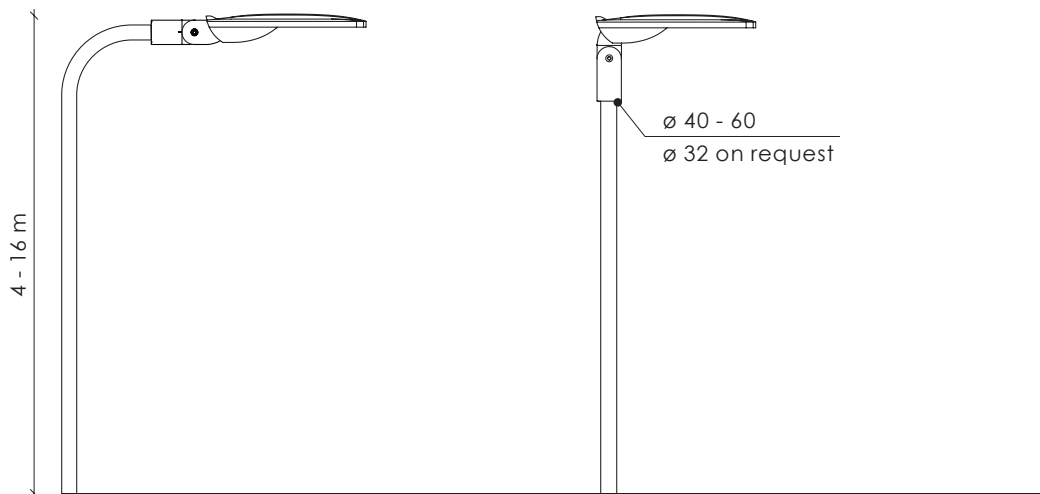

Horizontal entry

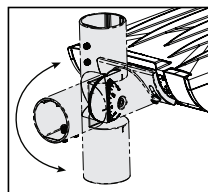

$\pm 90^\circ$

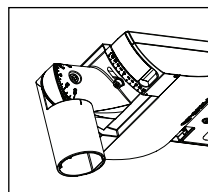

Vertical entry

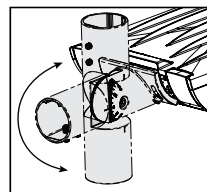

$\pm 90^\circ$

Note! Only those models with fixed mounting position (0° relative to the ground) are DarkSky approved!

Stork little brother

with 76 mm adjustable console

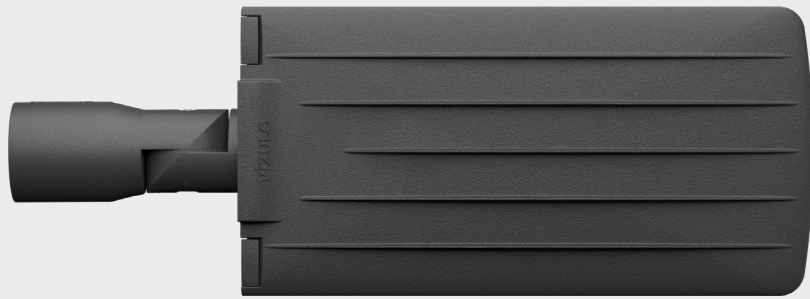

Note! Glass with gray print is standard
(black print glass on request!)



RAL7035



RAL9006



DB703



RAL9005

Other colors
available on request

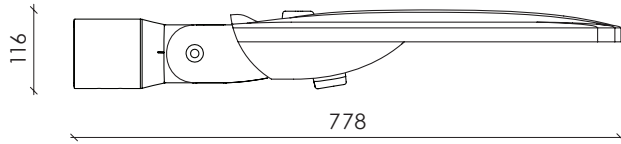
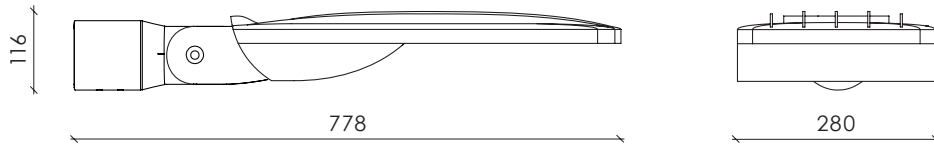

Dimensions with 2 Zhaga connectors

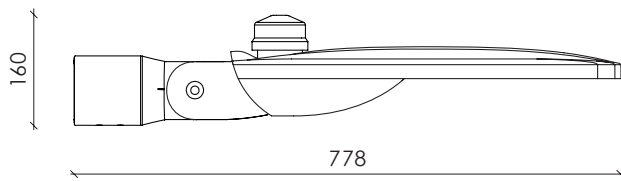

Dimensions with NEMA socket

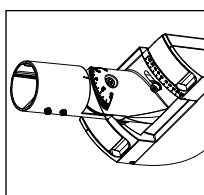
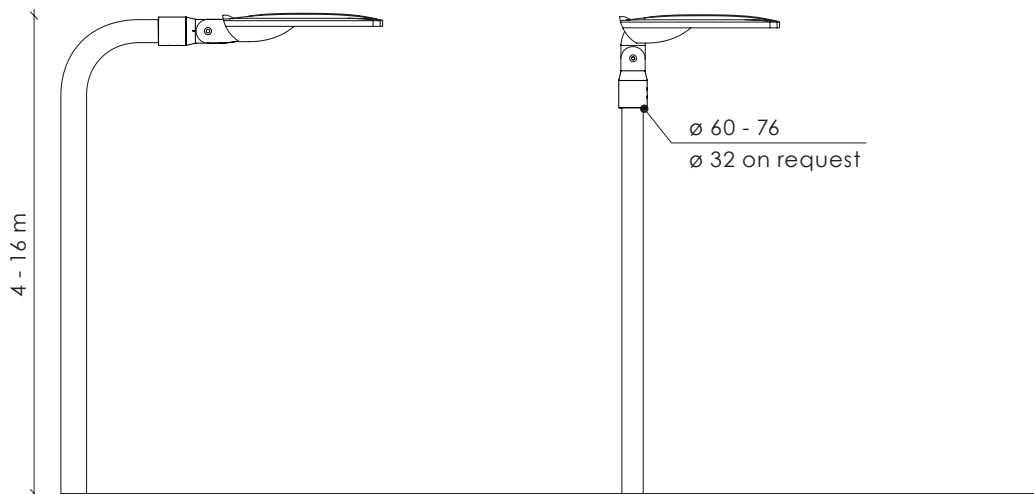

Horizontal entry

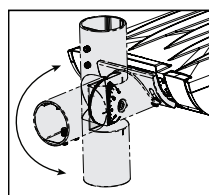

$\pm 90^\circ$

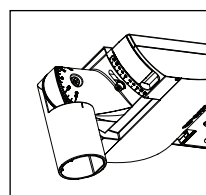

Vertical entry

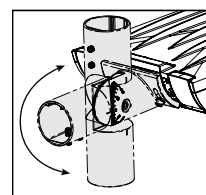

$\pm 90^\circ$

Note! Only those models with fixed mounting position (0° relative to the ground) are DarkSky approved!

Technical information



V	198 - 264 / 110 - 277 / 90 - 305 ¹⁾
Hz	50 - 60
W	5 - 200
lm	487 - 29512 ²⁾
lm/W	98 - 194 ³⁾
K	2700 / 3000 / 4000 / TW 2700 - 6500 ⁴⁾
°C	-40 up to +50 ⁵⁾
CRI	>70 / >80 / >90 ⁴⁾

Body:	Die-cast aluminium
Dimming:	DALI / 1-10 V / Midnight dimming / Step dimming / Mains dimming
Initial chromaticity:	MacAdam 5
Lifetime:	Eco 100 000 h (L90B10) at Ta = 25 °C* Standard 100 000 h (L98B10) at Ta = 25 °C* High density 100 000 h (L98B10) at Ta = 25 °C*
Warranty:	5 years
Installation:	Tool-less
Spigot:	32 - 40 mm ⁶⁾ / 40 - 60 mm / 60 - 76 mm
Socket:	NEMA Top / Zhaga Top and Bottom
Intelligent Control:	Stand-alone / Group / CMS
Sensor:	Motion / Motion + Daylight / Daylight
Surge protection:	4 / 6 / 10 kV ⁷⁾
Nature friendly:	PC Amber / Red / 1800 K
Corrosion protection:	Up to C5
Neto weight:	Up to 7.53 kg
Max. wind load area, SCd:	0.04 m ²

¹⁾ Maximum operating voltage, ENEC certificate voltage 198 - 264 V / 90 - 305 V, UL certificate voltage 110 - 277 V

²⁾ Lumen output indicated at CRI > 70

³⁾ This value depends from configuration and can reach even higher number when max efficient components are combined

⁴⁾ 1800 / 2200 / 3500 / 5000 / 5700 / 6500 K available on request along with other not listed CRI and CCT

Note! Only fixtures with CCT of 3000 K or lower are DarkSky approved!

⁵⁾ Operating temperature differs depending on chosen output wattage

⁶⁾ Achievable with an adapter for 40 - 60 mm spigot

⁷⁾ 10 kV (L-N; L/N-PE) surge protection device available on request

⁸⁾ Check SundaHus web page for product assessment results

* This value is only informative and may change according to selected article. LED Lifetime is strongly depending from LEDs current and junction temperature – increase in LED current and luminaire power lead to increase of junction temperature and as consequence lifetime decrease. Thus, luminaire models with lower power, lower current (and lower junction temperature) will have higher lifetime than standard models. And high power and high current luminaire models may have negative lifetime deviation comparing to standard models. To receive precise value please contact VIZULO export representatives.

Technical parameters for final product can differ from typical data by 7% due to special conditions of LED manufacturing processes.

Standard modules

* Data for L01 optic.

Check VIZULO members section for additional information

4000 K | CRI 70

Number of LED's	8			16			32		
Nominal current, mA	140	500	700	280	500	760	280	500	750
Power, W	5	14	19	15	26	39	28	50	75
Luminous Flux, lm	570	1900	2540	2180	3600	5300	4500	7550	10650
Efficacy, lm/W	114	136	134	145	138	136	161	151	142
Power factor, PF	Up to 0.94			Up to 0.98			Up to 0.97		

Number of LED's	48			64		
Nominal current, mA	270	500	690	250	500	700
Power, W	40	75	102	50	98	137
Luminous Flux, lm	6360	11000	14800	8000	15000	19800
Efficacy, lm/W	159	147	145	160	153	145
Power factor, PF	Up to 0.96			Up to 0.98		

Luminaire efficacy	2700 K	5 - 137 W	487 - 17000 lm	98 - 140 lm/W
	3000 K	5 - 137 W	540 - 18500 lm	108 - 152 lm/W
	5000 K	5 - 137 W	570 - 19800 lm	114 - 161 lm/W
	5700 K	5 - 137 W	570 - 19800 lm	114 - 161 lm/W

High density modules

* Data for V01 optic.

Check VIZULO members section for additional information

4000 K | CRI 70

Number of LED's	24			128		
Nominal current, mA	330	530	730	470	490	515
Power, W	25	40	55	178	185	200
Luminous Flux, lm	3770	5835	7655	27265	28179	29512
Efficacy, lm/W	151	146	139	153	152	148
Power factor, PF	Up to 0.98			Up to 0.99		

Luminaire efficacy	2700 K	25 - 200 W	3231 - 25295 lm	119 - 138 lm/W
	3000 K	25 - 200 W	3553 - 27826 lm	129 - 152 lm/W
	5000 K	25 - 200 W	3770 - 29512 lm	135 - 158 lm/W
	5700 K	25 - 200 W	3770 - 29512 lm	135 - 158 lm/W

Check VIZULO members section for additional information

4000 K | CRI 70

Number of LED's	8			16			24			32		
Nominal current, mA	280	490	700	200	480	705	270	490	700	250	495	695
Power, W	15	26	38	20	50	75	40	75	110	50	100	145
Luminous Flux, lm	2240	3720	4090	3215	7225	10080	6380	10945	14795	8000	14550	19475
Efficacy, lm/W	149	143	134	161	144	134	160	146	135	160	146	134
Power factor, PF	Up to 0.98			Up to 0.98			Up to 0.98			Up to 0.99		

Number of LED's	36			48			64		
Nominal current, mA	265	490	690	270	500	655	455	470	505
Power, W	60	110	160	80	150	200	178	185	200
Luminous Flux, lm	9425	16130	21644	12740	21710	27420	26510	27340	29065
Efficacy, lm/W	157	147	135	159	145	137	149	148	145
Power factor, PF	Up to 0.99			Up to 0.99			Up to 0.99		

Luminaire efficacy	2700 K	15 - 200 W	2087 - 27050 lm	125 - 150 lm/W
	3000 K	15 - 200 W	2146 - 27815 lm	128 - 154 lm/W
	5000 K	15 - 200 W	2221 - 28780 lm	133 - 159 lm/W
	5700 K	15 - 200 W	2190 - 28380 lm	131 - 157 lm/W

Model name principles

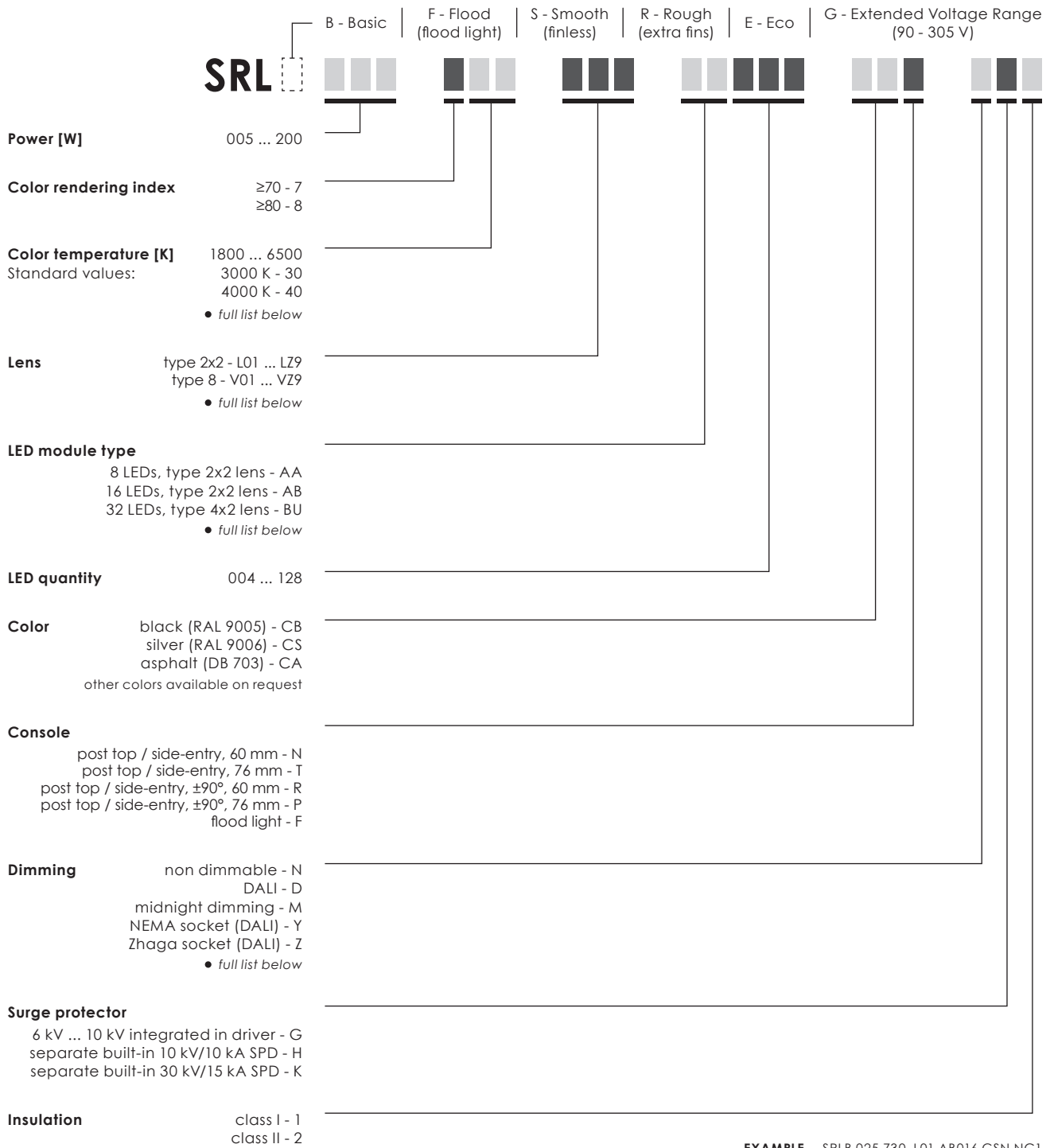

● Full list of options

Color temperature [K]

1800 ... 6500
2700 K - 27
3000 K - 30
4000 K - 40
Tunable White 2700-6500 - TW
Nature Friendly Red - NR
Nature Friendly Amber - NA
Nature Friendly 1800 K - NK

Lens

type 8 - V01 ... VZ9
type 2x2 - L01 ... LZ9
type 4x2 - B01 ... BZ9
type 6x1 - T01 ... TZ9
type 12 - Y01 ... YZ9
type 1 - Z01 ... ZZ9
custom configuration - M01 ... NZ9

Dimming

non dimmable - N
DALI - D
1-10 V - A
midnight dimming - M
midnight dimming + DALI - R
step dimming - S
mains dimming - L
wireless - W
NEMA socket (DALI) - Y
Zhaga socket (DALI) - Z
*custom configuration - X

LED module type

8 LEDs, type 2x2 lens - AA
16 LEDs, type 2x2 lens - AB
16 LEDs, type 8 lens - AF
32 LEDs, type 8 lens - AG
4 LEDs, type 2x2 lens - BG
8 LEDs, type 8 lens - BH
16 LEDs, type 4x2 lens - BT
32 LEDs, type 4x2 lens - BU

* CUSTOM CONFIGURATION EXAMPLE

NEMA socket + Zhaga socket; NEMA socket + Zhaga socket + midnight dimming; etc.
Custom configuration information is available in order confirmation.

LED modules

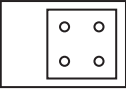
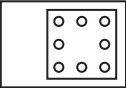
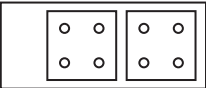
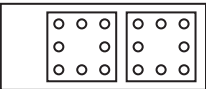
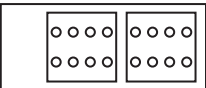
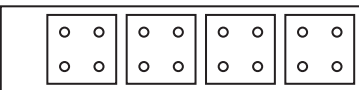
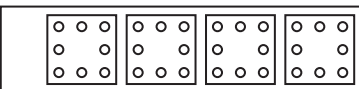
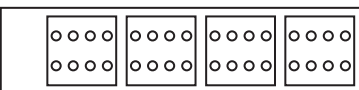
Type	Max module quantity	Min LED quantity per module	Max LED quantity per module	Max LED quantity per luminaire	LED step	LED type	Lens type	Layout
BG	4	2	4	16	2	Standard Eco	type 2x2 L01...LZ9	
BH	4	2	8	32	4	Standard	type 8 V01...VZ9	
AA	4	4	8	32	2	Standard Eco	type 2x2 L01...LZ9	
AF	4	4	16	64	4	Standard	type 8 V01...VZ9	
BT	4	4	16	64	4	Standard	type 4x2 B01...BZ9	
AB	4	8	16	64	2	Standard Eco	type 2x2 L01...LZ9	
AG	4	16	32	128	4	Standard	type 8 V01...VZ9	
BU	4	16	32	128	4	Standard	type 4x2 B01...BZ9	

Cable core count

Socket	Dimming	Model number abbreviation	Input cable core count - Class I	Input cable core count - Class II
None	None	N	3	2
None	DALI	D	5	4
None	Midnight dimming	M	3	2
None	Midnight dimming + DALI	R	5	4
None	Step dimming	S	5 ⁽¹⁾	4 ⁽¹⁾
None	Mains dimming	L	3	2
Zhaga	DALI	Z	3 ⁽²⁾	2 ⁽²⁾
Zhaga	Midnight dimming	X	3	2
Zhaga	Mains dimming	X	3	2
NEMA	DALI	Y	3 / 5 ⁽³⁾	2 / 4 ⁽³⁾
NEMA	Midnight dimming	X	3	2
NEMA	Step dimming	X	5 ⁽¹⁾	4 ⁽¹⁾
NEMA	Mains dimming	X	3	2

¹⁾ 1 core unused

²⁾ DALI wires used only for internal connection between driver and Zhaga socket(s)

³⁾ +2 cores for external DALI connection

Tool-less access to the power supply

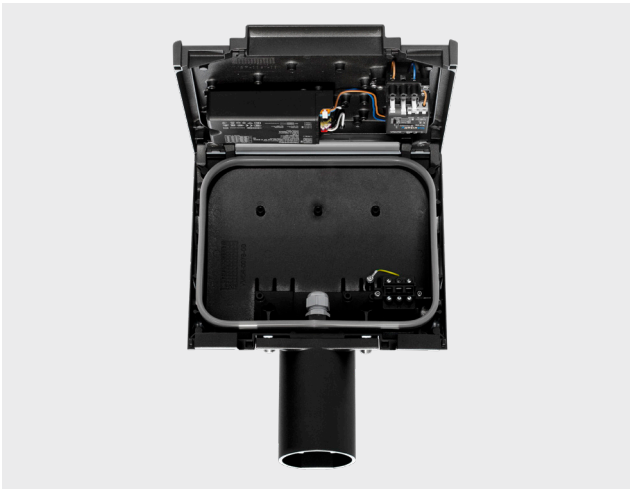
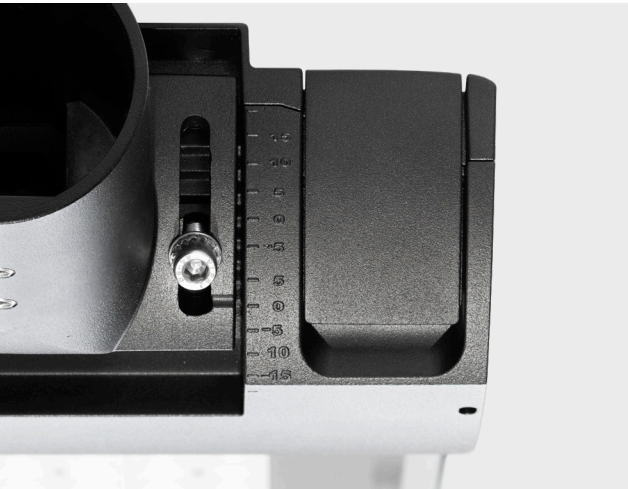

Optics

Standard modules

L01

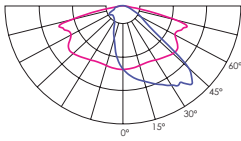

L02

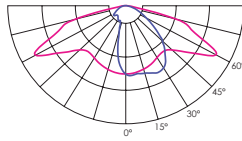

L03

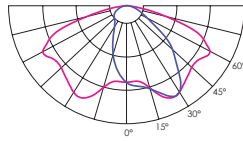

L04

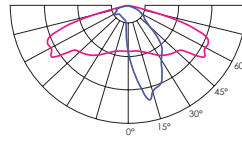

L05

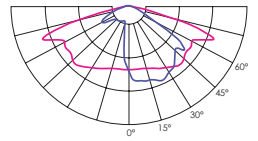

L06

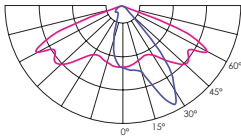

L07

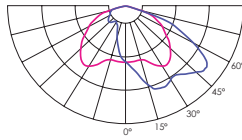

L08

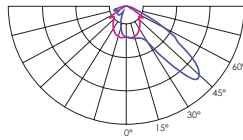

L09

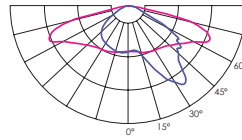

L10

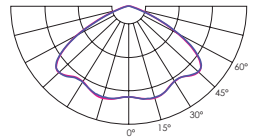

L11

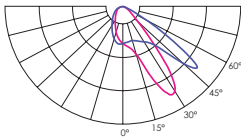

L12

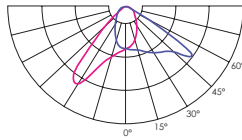

L13

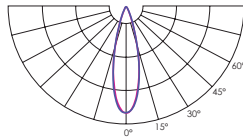

L14

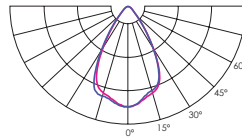

L15

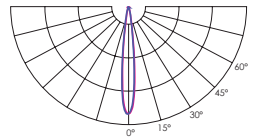

L16

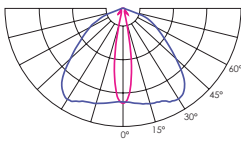

L17

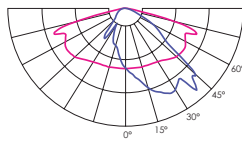

L18

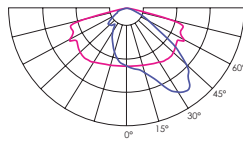

L19

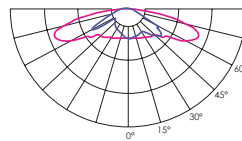

L20

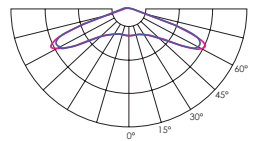

L22

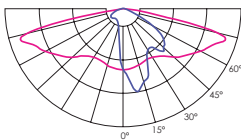

L23

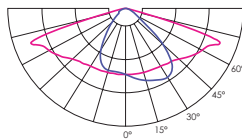

L35

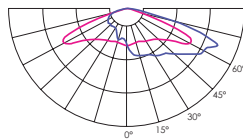

L36

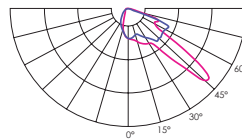

L37

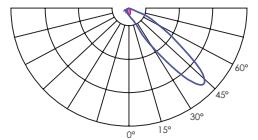

L38

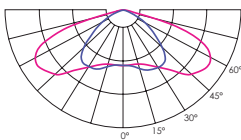

L40

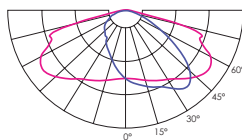

L41

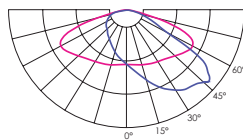

L42

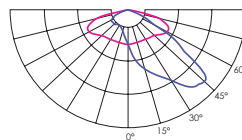

L46

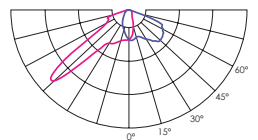

L55

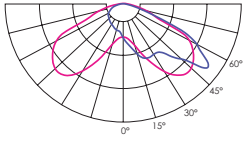

L56

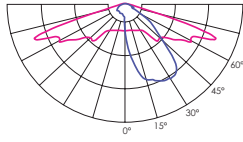

L58

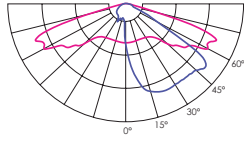

L60

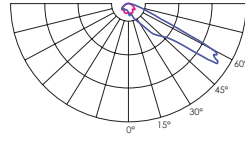

L63

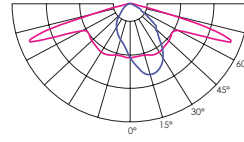

L66

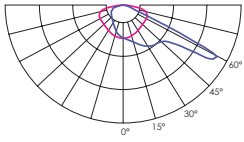

L88

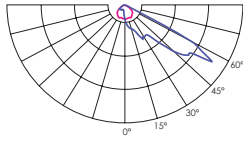

L90

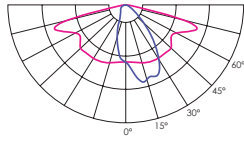

L94

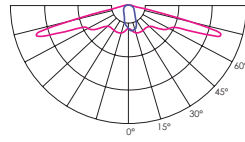

LB2

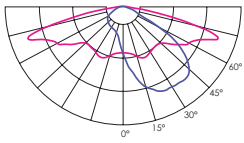

LB3

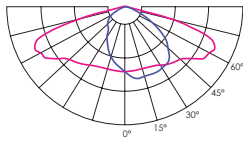

LC1

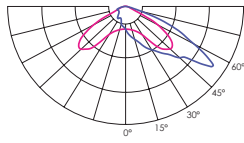

High density modules

V01

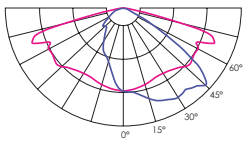

V04

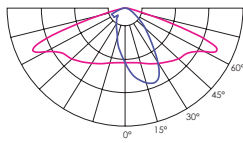

V05

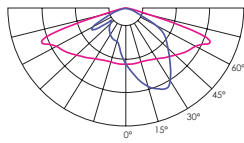

V10

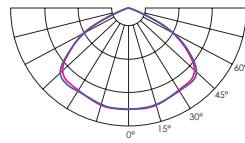

V13

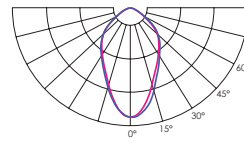

V16

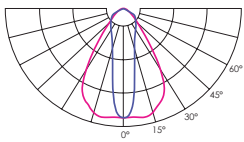

V20

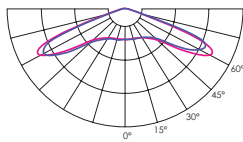

V22

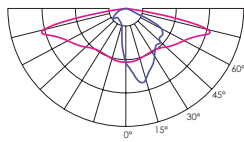

V35

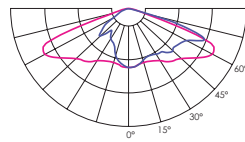

V45

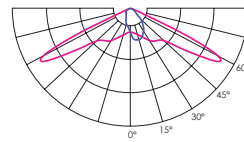

V52

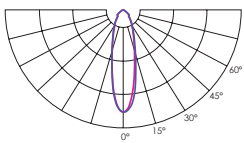

V53

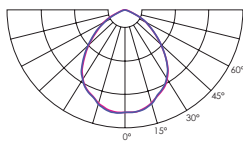

V57

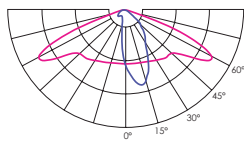



Pedestrian crossing optics



V	198 - 264 / 110 - 277 / 90 - 305 ¹⁾
Hz	50 - 60
W	5 - 137 ²⁾ 15 - 200 ³⁾
lm	Up to 19800 ²⁾ Up to 29065 ³⁾
lm/W	Up to 194 ⁴⁾
K	2700 / 3000 / 4000 / TW 2700 - 6500 ⁵⁾
°C	-40 up to +50 ⁶⁾
CRI	>70 / >80 / >90 ⁵⁾

Body:	Die-cast aluminium
Dimming:	DALI / 1-10 V / Midnight dimming / Step dimming / Mains dimming
Initial chromaticity:	MacAdam 5
Lifetime:	Eco 100 000 h (L90B10) at Ta = 25 °C* Standard 100 000 h (L98B10) at Ta = 25 °C*
Warranty:	5 years
Installation:	Tool-less
Spigot:	32 - 40 mm ⁷⁾ / 40 - 60 mm / 60 - 76 mm
Socket:	NEMA Top / Zhaga Top and Bottom
Intelligent Control:	Stand-alone / Group / CMS
Sensor:	Motion / Motion + Daylight / Daylight
Surge protection:	4 / 6 / 10 kV ⁸⁾
Nature friendly:	PC Amber / Red / 1800 K
Corrosion protection:	Up to C5
Neto weight:	Up to 7.53 kg
Max. wind load area, SCd:	0.04 m ²

¹⁾ Maximum operating voltage, ENEC certificate voltage 198 - 264 V / 90 - 305 V, UL certificate voltage 110 - 277 V

²⁾ Standard modules, lumen output indicated at CRI > 70

³⁾ ECO modules, lumen output indicated at CRI > 70

⁴⁾ This value depends from configuration and can reach even higher number when max efficient components are combined

⁵⁾ 1800 / 2200 / 3500 / 5000 / 5700 / 6500 K available on request along with other not listed CRI and CCT

Note! Only fixtures with CCT of 3000 K or lower are DarkSky approved!

⁶⁾ Operating temperature differs depending on chosen output wattage

⁷⁾ Achievable with an adapter for 40 - 60 mm spigot

⁸⁾ 10 kV (L-N; L/N-PE) surge protection device available on request

⁹⁾ Check SundaHus web page for product assessment results

* This value is only informative and may change according to selected article. LED Lifetime is strongly depending from LEDs current and junction temperature – increase in LED current and luminaire power lead to increase of junction temperature and as consequence lifetime decrease. Thus, luminaire models with lower power, lower current (and lower junction temperature) will have higher lifetime than standard models. And high power and high current luminaire models may have negative lifetime deviation comparing to standard models. To receive precise value please contact VIZULO export representatives.

Technical parameters for final product can differ from typical data by 7% due to special conditions of LED manufacturing processes.

Right side traffic

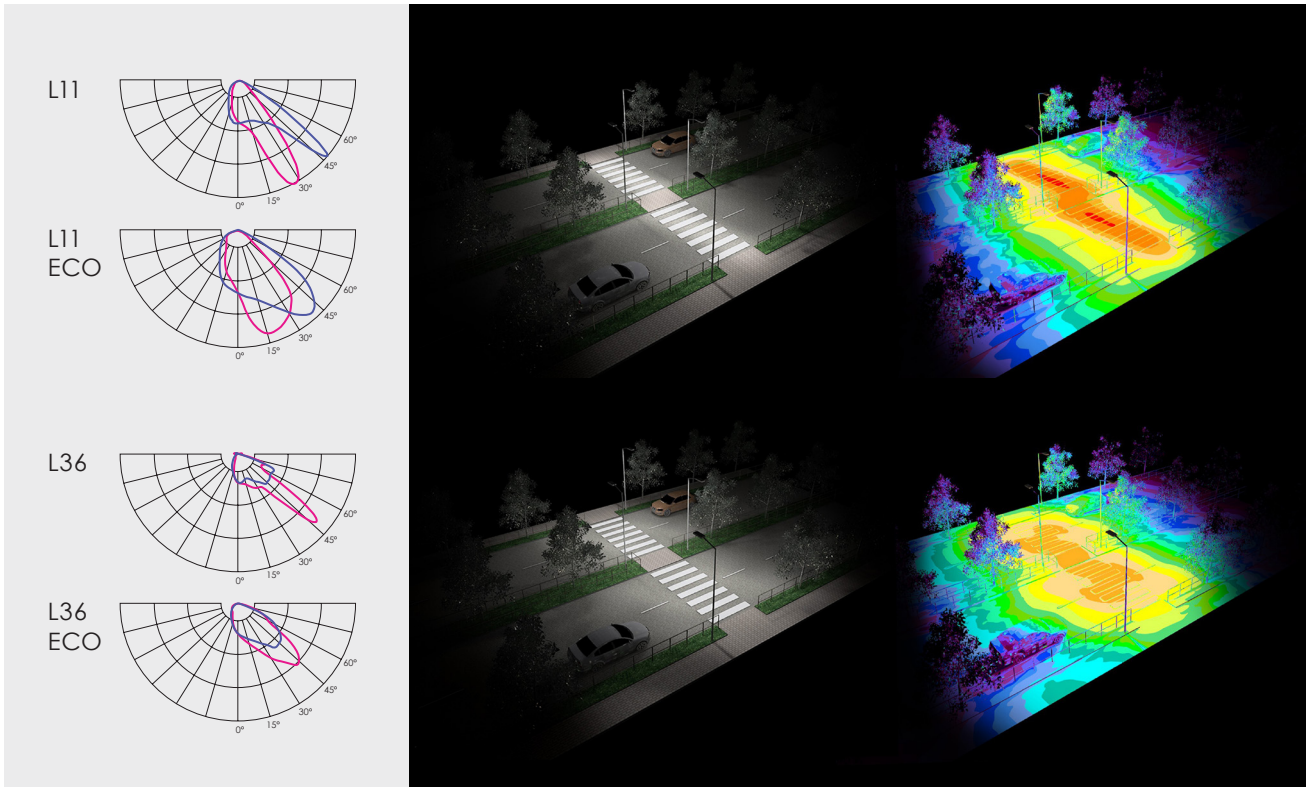

Left side traffic

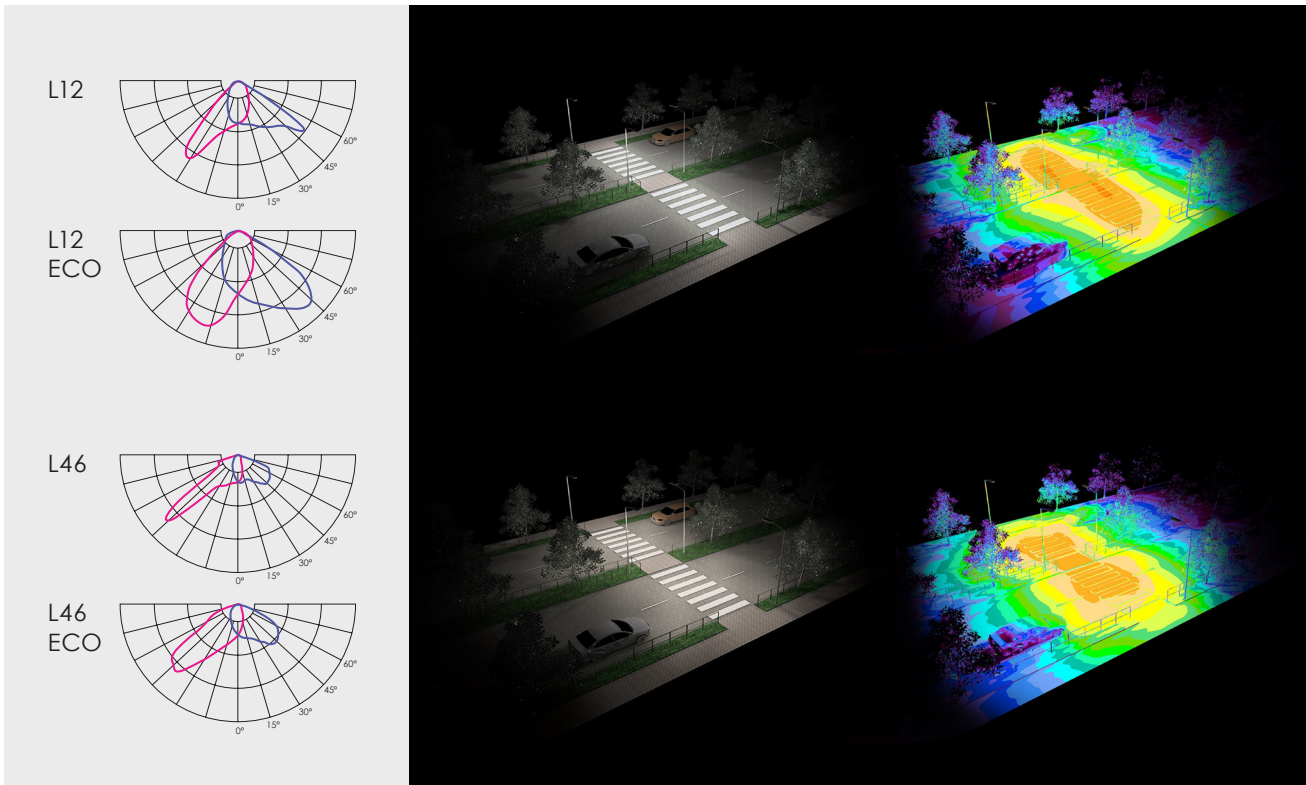

Backlight cutter

Backlight cutter | black

Art. 70000661

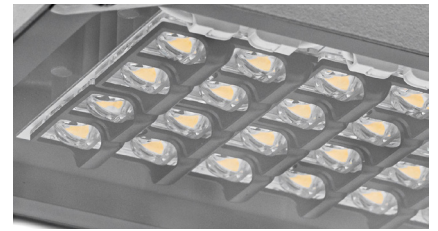

Backlight cutter | white

Art. 70000662



Optical losses from 10% to 31% depending from used optic.

Without backlight cutter

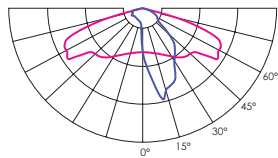

Backlight cutter | black

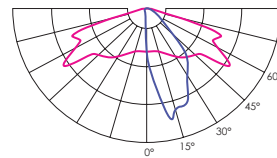

Backlight cutter | white

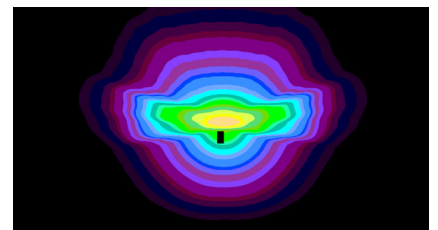
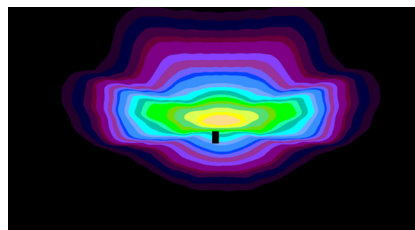
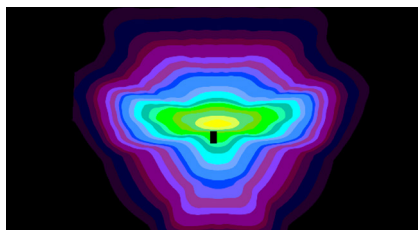
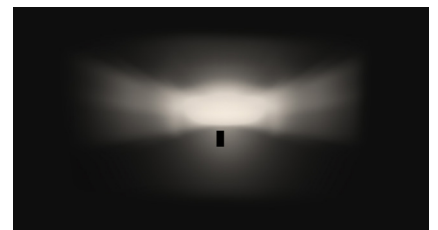
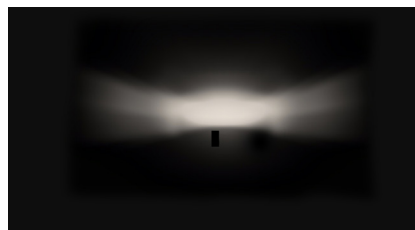
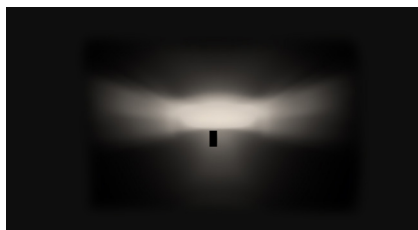
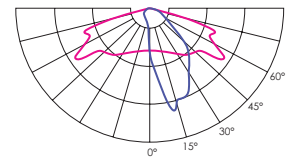

Visors



SRL back visor | silver (RAL9006)

Art. 70044156

↳ Back visor



SRL front visor | silver (RAL9006)

Art. 70044155

↳ Back + front visor



SRL left side visor | silver (RAL9006)

Art. 70044157

SRL right side visor | silver (RAL9006)

Art. 70044158

↳ Back + front + side visors

SRL visor set | silver (RAL9006)

Art. 70044190

Accessories

MAUGLO Segment controller

Art. 70010004

Segment Controller receives commands from MAUGLO server via GSM and transmits tasks to Luminaire Controller via radio frequency communication.

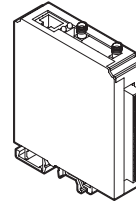

MAUGLO Luminaire controller

Art. 70010001 /
LC2M-23-05-R Luminaire
Controller - 2 relays

Luminaire Controller is wireless mesh-networking device that uses 868 MHz for communication with Segment Controller and other Luminaire Controllers. It is delivered in various configurations to meet the needs of your applications.

Art. 70010002 /
LC2M-12-05-R Luminaire
Controller - 1 relay

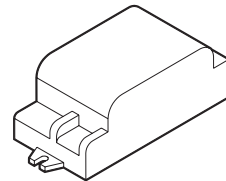

MAUGLO Surge Protection device

Art. 70020001

Surge Protection device offers protection against lighting surges;

Voltage Protection level up (L-N) $\leq 1,5$ kV

Voltage Protection level up (L/N-PE) $\leq 2,0$ kV

$U_{oc} = 10$ kV

$I_{max} = 10$ kA

$I_{nom} = 5$ kA

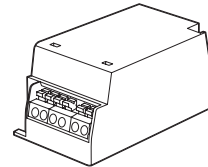

Radio Frequency Antenna

Art. 70000108

Heavy duty IP67 enclosure

Mounted in cabinet or luminaire body

with 14 mm screw

SMA connector



NEMA Socket

2213362-3, 5 pin NEMA socket 105°C wires

Art. 70000362

2213362-4, 7 pin NEMA socket 105°C wires

Art. 70000333

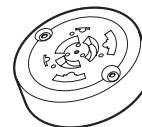

Dummy Link for NEMA Socket

Art. 70000113



MSLC205RG Luminaire controller + radar, Zhaga, 80 mm

Art. 70010027

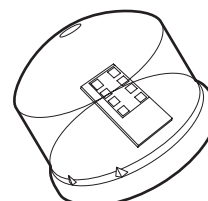

**MSLC205RGL Luminaire controller,
Zhaga, 80 mm**

Art. 70010029

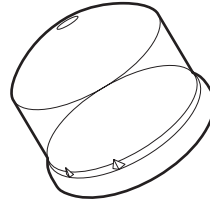

Zhaga socket no cap

Art. 70000612



Zhaga socket with cap

Art. 70000613



Console adapter

40 mm to 30 mm

Art. 70055002

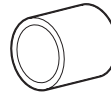

Console adapter

Spigot size 60 - 76 mm

Art. 70044002

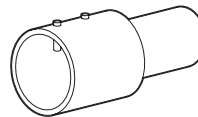

Wall mounting bracket

Spigot size 40 - 60 mm

Art. 70044001

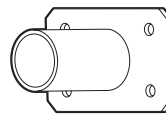

Wall mounting bracket

Vertical

Art. 70044004

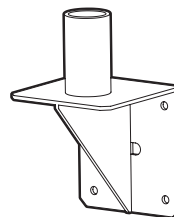

Console 76 mm

76 mm - Stork/ Stork LB

	RAL7035	Art. 70044177
	RAL9006	Art. 70044011
	DB703	Art. 70044179
	RAL9005	Art. 70044178

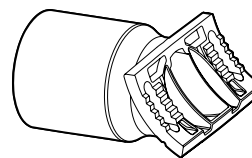

Adjustable Console ±90°

60 mm - Stork/ Stork LB

	RAL7035	Art. 70044012
	RAL9006	Art. 70044080
	RAL9005	Art. 70044141

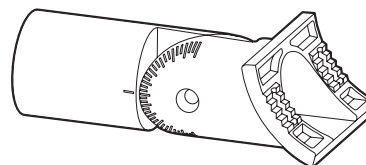

Adjustable Console ±90°

76 mm - Stork/ Stork LB

	RAL7035	Art. 70044176
	RAL9006	Art. 70044013
	RAL9005	Art. 70044142

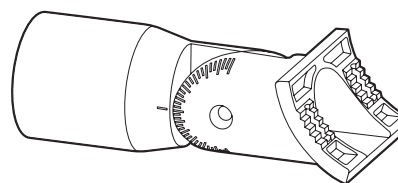

Device connector

Art. 70000315

IP66 rated connector offers easy installation of the street luminaires.
4 wire cable connector without PE connection.

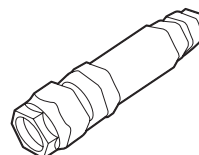

Connector

Art. 70000313

IP66 rated connector offers easy installation of the street luminaires.
3 wire cable connector

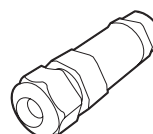

Connector

Art. 70000304

IP66 rated connector offers easy installation of the street luminaires.
5 wire cable connector

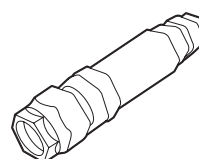

Connection cable

Art. 70000363

Male - free end, length 1 m, RST20i3, 3 pole, 250 V,
16 A, cable type H05VV, cross section 1,5 mm²

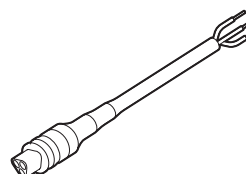

**Pre-installed cable sets
For external power supply**

0,5 m long cable.....	Art. 70000436
5 m long cable.....	Art. 70000437
6 m long cable.....	Art. 70000438
8 m long cable.....	Art. 70000439
10 m long cable.....	Art. 70000440
12 m long cable.....	Art. 70000441
18 m long cable.....	Art. 70000442
20 m long cable.....	Art. 70000443
22 m long cable.....	Art. 70000444
25 m long cable.....	Art. 70000445

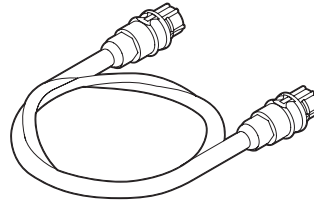

**Pre-installed cable sets
For internal power supply**

2 x 1,5 mm - 0,5 m long cable.....	Art. 70000418
2 x 1,5 mm - 5 m long cable.....	Art. 70000342
2 x 1,5 mm - 6 m long cable.....	Art. 70000337
2 x 1,5 mm - 8 m long cable.....	Art. 70000344
2 x 1,5 mm - 10 m long cable.....	Art. 70000338
2 x 1,5 mm - 12 m long cable.....	Art. 70000345
2 x 1,5 mm - 18 m long cable.....	Art. 70000419

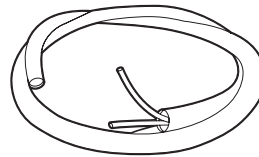

3 x 1,5 mm - 0,5 m long cable.....	Art. 70000319
3 x 1,5 mm - 5 m long cable.....	Art. 70000320
3 x 1,5 mm - 6 m long cable.....	Art. 70000321
3 x 1,5 mm - 8 m long cable.....	Art. 70000322
3 x 1,5 mm - 10 m long cable.....	Art. 70000323
3 x 1,5 mm - 12 m long cable.....	Art. 70000324
3 x 1,5 mm - 18 m long cable.....	Art. 70000325
3 x 1,5 mm - 20 m long cable.....	Art. 70000425
3 x 1,5 mm - 22 m long cable.....	Art. 70000426
3 x 1,5 mm - 25 m long cable.....	Art. 70000427
3 x 1,5 mm - 32 m long cable.....	Art. 70000430
3 x 1,5 mm - 42 m long cable.....	Art. 70000431
3 x 1,5 mm - 50 m long cable.....	Art. 70000432

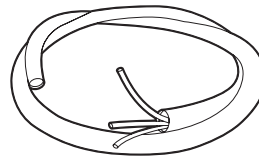

5 x 1,5 mm - 0,5 m long cable.....	Art. 70000305
5 x 1,5 mm - 5 m long cable.....	Art. 70000316
5 x 1,5 mm - 6 m long cable.....	Art. 70000317
5 x 1,5 mm - 8 m long cable.....	Art. 70000318
5 x 1,5 mm - 10 m long cable.....	Art. 70000306
5 x 1,5 mm - 12 m long cable.....	Art. 70000307
5 x 1,5 mm - 18 m long cable.....	Art. 70000308
5 x 1,5 mm - 20 m long cable.....	Art. 70000428
5 x 1,5 mm - 22 m long cable.....	Art. 70000429
5 x 1,5 mm - 25 m long cable.....	Art. 70000429
5 x 1,5 mm - 32 m long cable.....	Art. 70000433
5 x 1,5 mm - 42 m long cable.....	Art. 70000434
5 x 1,5 mm - 50 m long cable.....	Art. 70000435

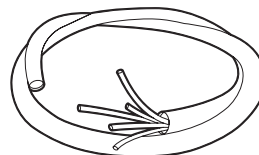

Certification



CE – conformity with European Union's health, safety and environmental protection standards

The CE mark is placed on products to state conformity with the relevant EU health, safety and environmental protection standards. In case of electronic products, the standards are, for example, the Restriction of Hazardous Substances in Electrical and Electronic Equipment (RoHS) directive, Waste Electrical and Electronic Equipment (WEEE) directive, the Electromagnetic Compatibility (EMC) directive etc. The mark ensures that the product can be sold anywhere in the European Economic Area (EEA).



UKCA - conformity with the relevant essential requirements of Great Britain

UKCA is a product mark intended to demonstrate compliance with the directives set by Great Britain (England, Scotland and Wales). It is analogous to the European Union's CE marking, meaning that depending on the type of product the applicable regulations are different. In case of LED lighting, the relevant requirements are compliance with the Electromagnetic Compatibility Regulations, the Electrical Equipment (Safety) Regulations, the Restriction of the Use of Certain Hazardous Substances in Electrical and Electronic Equipment Regulations and the Ecodesign for Energy-Related Products and Energy Information (Lighting Products) Regulations.



EAC - compliance with the regulations of the Eurasian Customs Union

The EAC Mark demonstrates conformity with all technical regulations defined by the Eurasian Customs Union. The conformity is assessed by an accredited independent testing laboratory. The EAC marking is a requirement in order to place a product on the market of Russia and the Eurasian Economic Union.



RoHS – compliance with European Union's RoHS directive

The RoHS (Restriction of Hazardous Substances in Electrical and Electronic Equipment) directive restricts (with exceptions) the use of ten hazardous materials in the manufacture of various types of electronic and electrical equipment. The aim of the directive is to prevent the risks posed to human health and the environment related to the management of electronic and electrical waste.



Zhaga-D4i - compliance with the requirements of Zhaga Book 18 or 20 and DALI standard

The Zhaga-D4i Mark represents the fact that a product is certified following the Zhaga-D4i joint certification program – a program established by Zhaga and the DALI Alliance (DiiA). The Zhaga part of the Mark represents that a product meets the requirements of Zhaga Book 18 or 20 – Zhaga standards that describe a smart interface between outdoor luminaires and sensing/ communication nodes. The DALI Alliance part of the Mark signifies that the product conforms with the DALI standard for intelligent, IoT-ready luminaires.



UL - compliance with UL standards for LED lighting

UL stands for Underwriter Laboratories, a third-party certification company that's been around for over a century. UL sets industry-wide standards for products and performs testing according to these standards to ensure that the products marked with the UL mark are safe and high quality.



ENEC - compliance with European standards for electrical equipment

The ENEC Mark is the high quality European Mark for electrical equipment. It is governed by the European Testing Inspection Certification System which ensures that the testing of products is conducted at ENEC – accredited laboratories, following additional requirements regarding the testing procedures. The ENEC Mark means that the testing procedure was followed scrupulously and that the consumer can be certain of the product's safety and quality.



ENEC+ - compliance with European standards for LED – based electronic products

The ENEC+ Mark is the high quality European Mark for LED – based electronic products. It demonstrates the product's compliance with the IEC standards for performance of LED modules and LED based luminaires. The ENEC+ Mark can only be granted to a product that has already acquired the ENEC Mark.



DarkSky Approved - a DarkSky program seal of approval

DarkSky Approved certification is granted to outdoor lighting fixtures meeting the criteria outlined by DarkSky, an organization that aims to reduce light pollution, enabling clearer night skies and mitigating the impact on wildlife and human health. DarkSky Approved luminaires are shielded to cut off uplight, utilize energy-efficient light sources, and employ measures to limit glare. This certification reflects a dedication to responsible outdoor lighting, valued by communities, businesses, and individuals striving to protect nocturnal environments.



International EPD System – Environmental Product Declaration available

An Environmental Product Declaration (EPD) is a declaration of the materials, energy, transportation and other resources involved in the production, use and end-of life of a specific product. It is based on a Life Cycle Assessment (LCA) study that complies with standards EN ISO 14040 and EN ISO 14044. A product's EPD can help evaluate its impact on the environment and make sustainable choices.



Synergrid approved - compliance with Synergid requirements for LED lighting

Synergrid is a federation of electricity and natural gas network operators in Belgium. The Synergrid approval mark means that the product is compliant with the design, safety and performance requirements set by Synergrid. The approval can be confirmed by checking the official list of Synergrid approved luminaires on the Synergrid website.

SundaHus

SundaHus – product material data assessment

SundaHus i Linköping AB (publ) is a consulting company for the improvement of indoor environmental quality. The company conducts health and environmental assessments of building materials and assigns each product a letter evaluation:

- A** products that provide minimal health risks
- B** products that do not qualify for A, but do not match the criteria for C+, C- or D
- C+** products that risk exposure to substances of very high concern
- C-** products that risk exposure to toxic or volatile substances, as well as negatively impact the environment
- D** products that cannot be assessed due to insufficient data

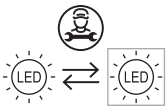

LED module replaceable by a professional

This pictogram shows that the LED modules included in the luminaire are only replaceable by a professional. This labeling is a requirement following the introduction of European Union's Regulation on energy labelling for light sources (EU) 2019/2015.

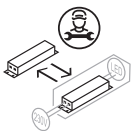

LED driver replaceable by a professional

This pictogram shows that the LED driver included in the luminaire is only replaceable by a professional. This labeling is a requirement following the introduction of European Union's Regulation on energy labelling for light sources (EU) 2019/2015.

References



Brehal | France



Gothenburg | Sweden





Hafnarfjörður | Iceland

VIZULO

Bukultu street 11
Riga, LV – 1005, Latvia

Sales: + 371 67 383 023
Production: + 371 67 383 024

sales@vizulo.com
www.vizulo.com

